

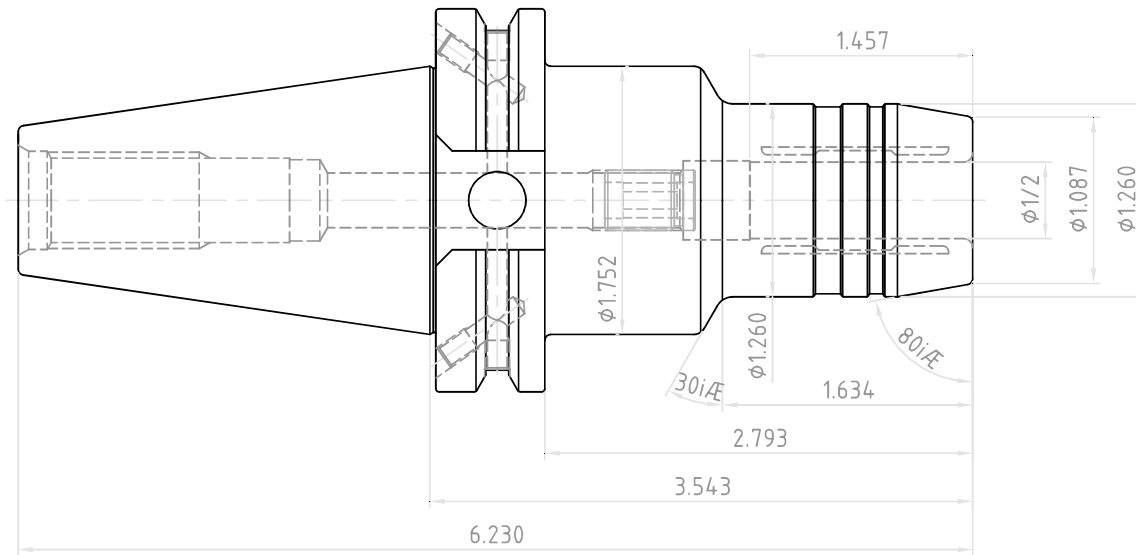

NO.	REVISIONS	DATE	DEVISER
1.			
2.			
3.			



 YG-1 CO., LTD.	DESCRIPTION		
	CCT40AD/B-HC1/2(12.7)-3.54(90)		
EDP No.	WB026	SCALE	1 : 1