

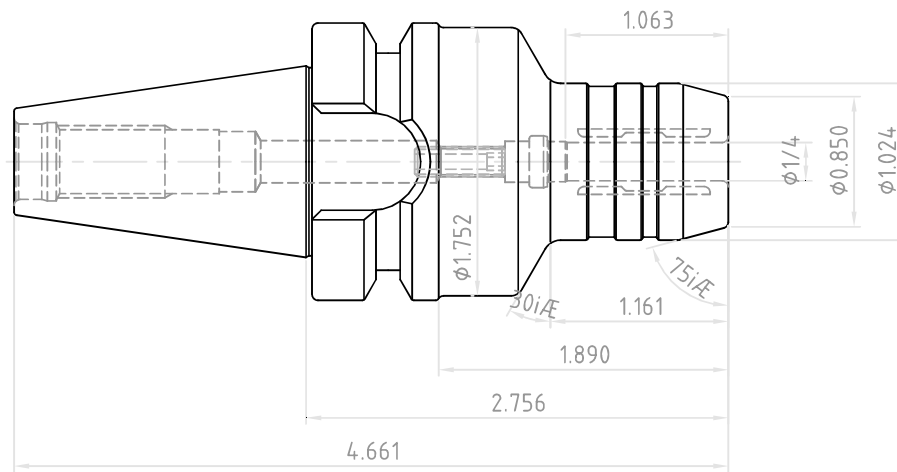

NO.	REVISIONS	DATE	DEVISER
1.			
2.			
3.			



 YG-1 CO., LTD.	DESCRIPTION	
	CBT30-HC1/4(6.35)-2.76(70)	
EDP No.	WD020	SCALE 1 : 1