

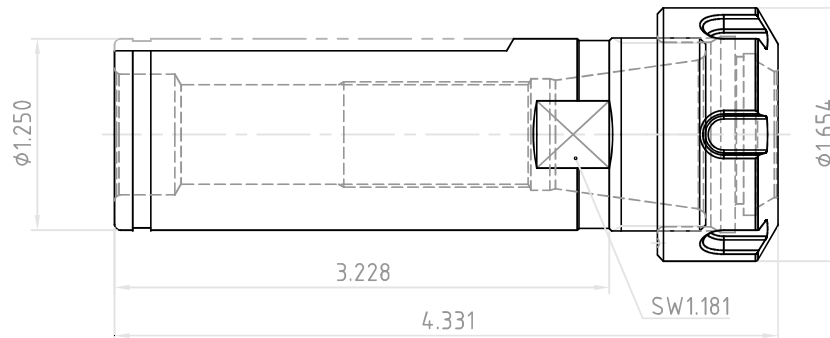

NO.	REVISIONS	DATE	DEVISER
1.			
2.			
3.			

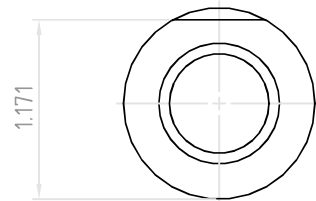

 YG-1 CO., LTD.	DESCRIPTION		
	NC1-1/4(31.75)-ER25		
	EDP No.	BN115	SCALE 1 : 1