

NO.	REVISIONS	DATE	DEVISER
1.			
2.			
3.			

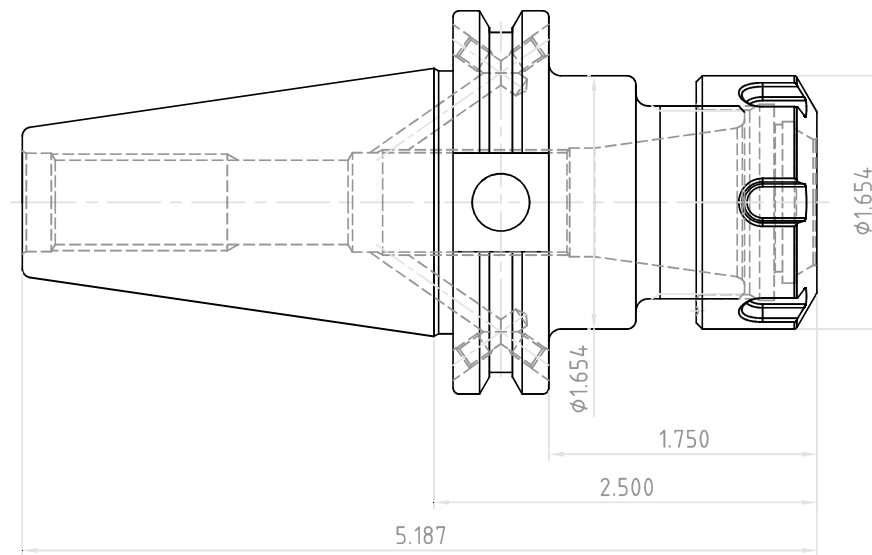

 YG-1 CO., LTD.	DESCRIPTION		
	CAT40AD/B-ER25-2.50(63.5)		
	EDP No.	BK233B	SCALE 1 : 1