

NO.	REVISIONS	DATE	DEVISER
1.			
2.			
3.			

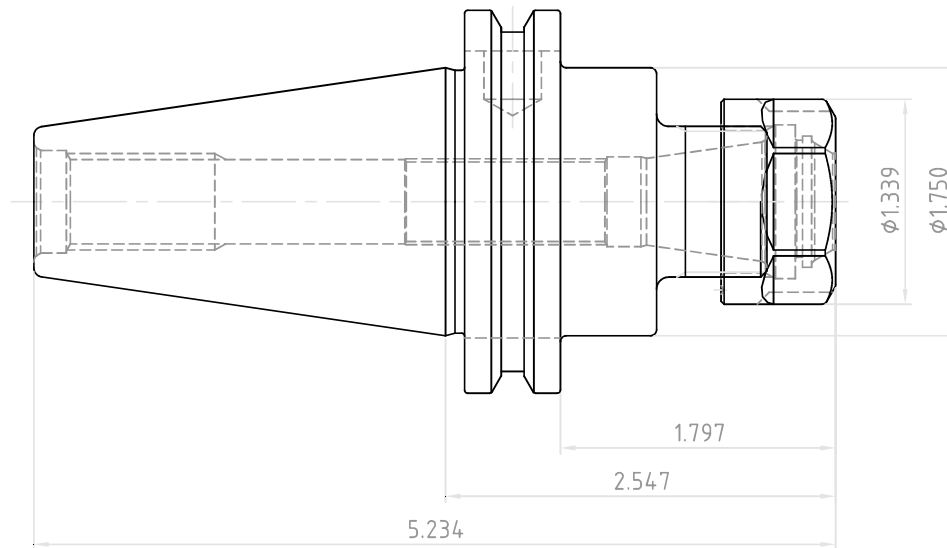

 YG-1 CO., LTD.	DESCRIPTION		
	CAT40-ER20-2.55(64.7)		
	EDP No.	BK232B25	SCALE 1 : 1