

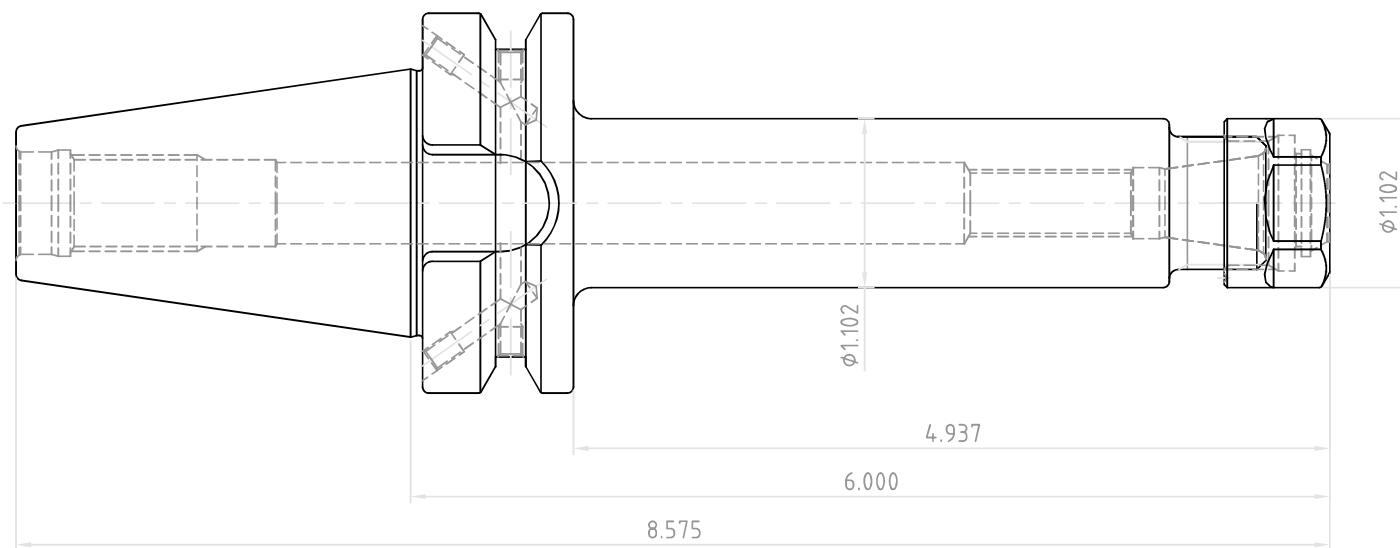

NO.	REVISIONS	DATE	DEVISER
1.			
2.			
3.			



 YG-1 CO., LTD.	DESCRIPTION		
	BT40AD/B-ER16-6.00(152.4)		
	EDP No.	BH331B	SCALE 1 : 1