

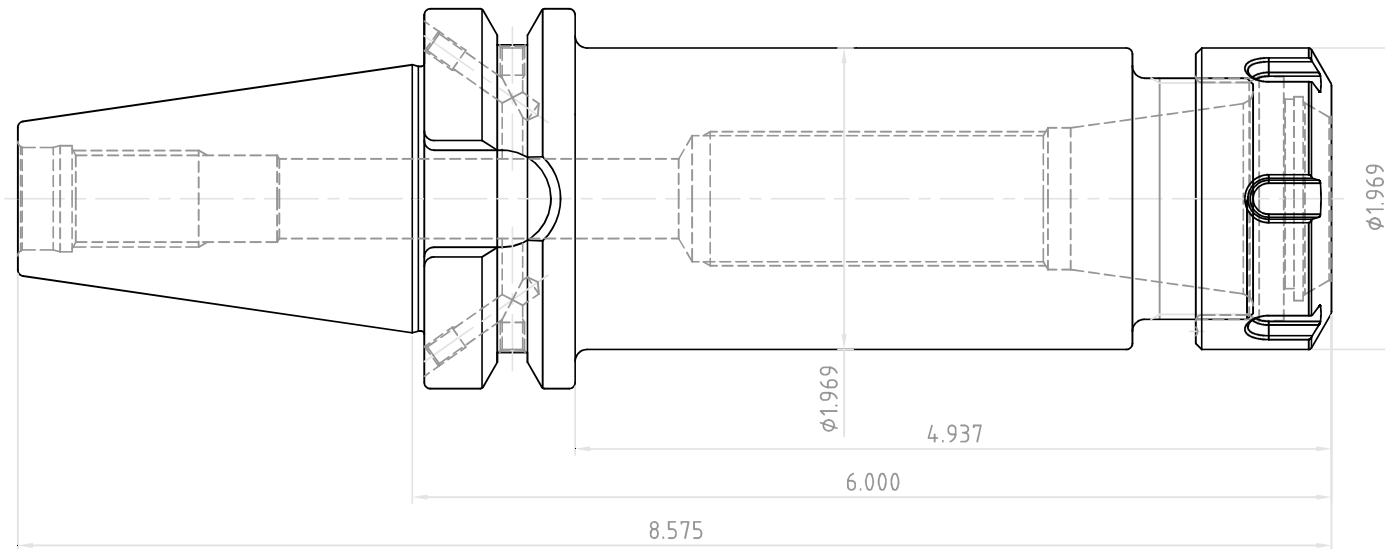

NO.	REVISIONS	DATE	DEVISER
1.			
2.			
3.			



 YG-1 CO., LTD.	DESCRIPTION	
	BT40AD/B-ER32-6.00(152.4)	
	EDP No.	BH334B
	SCALE	1 : 1