

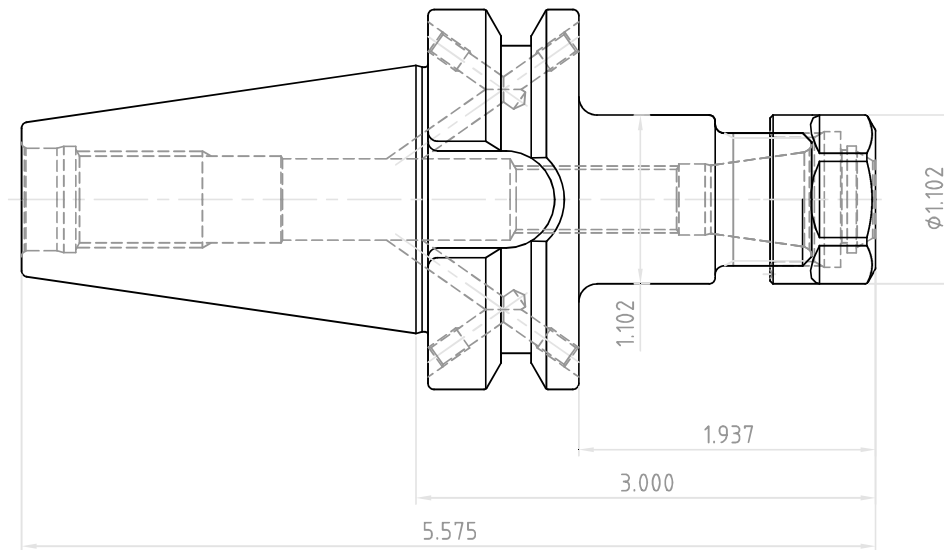

NO.	REVISIONS	DATE	DEVISER
1.			
2.			
3.			



 YG-1 CO., LTD.	DESCRIPTION		
	BT40AD/B-ER16-3.00(76.2)		
	EDP No.	BH031B	SCALE 1 : 1