

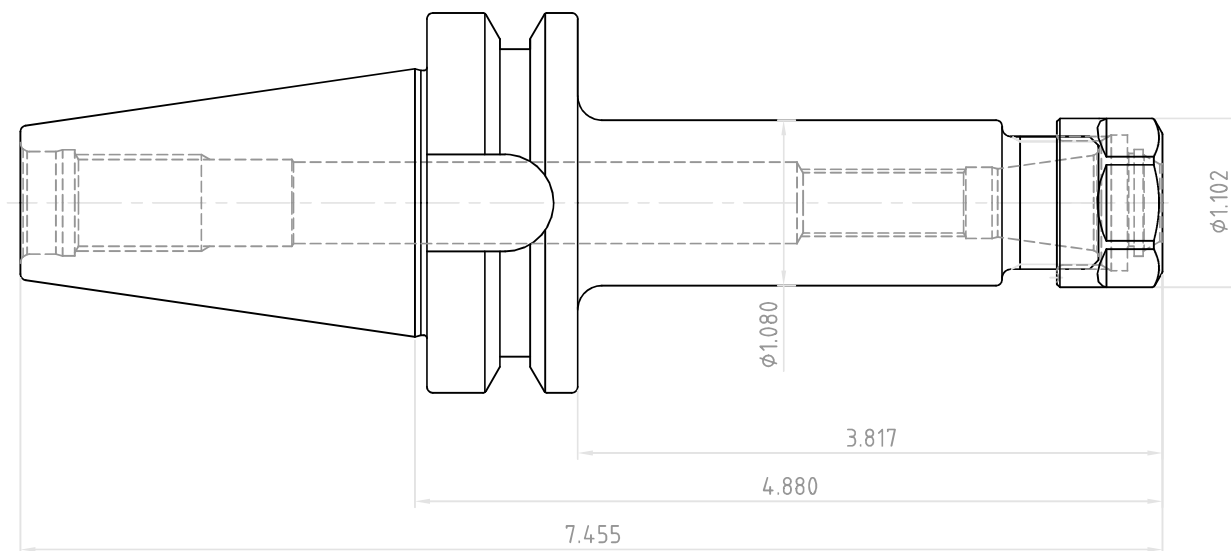

NO.	REVISIONS	DATE	DEVISER
1.			
2.			
3.			



 YG-1 CO., LTD.	DESCRIPTION		
	BT40-ER16-4.88(123.95)		
EDP No.	BH331B25	SCALE	1 : 1