

NO.	REVISIONS	DATE	DEVISER
1.			
2.			
3.			

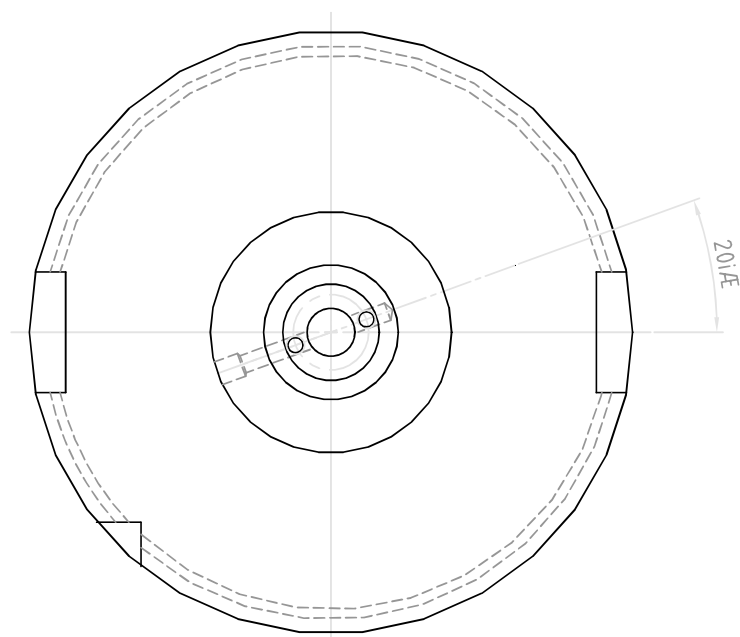
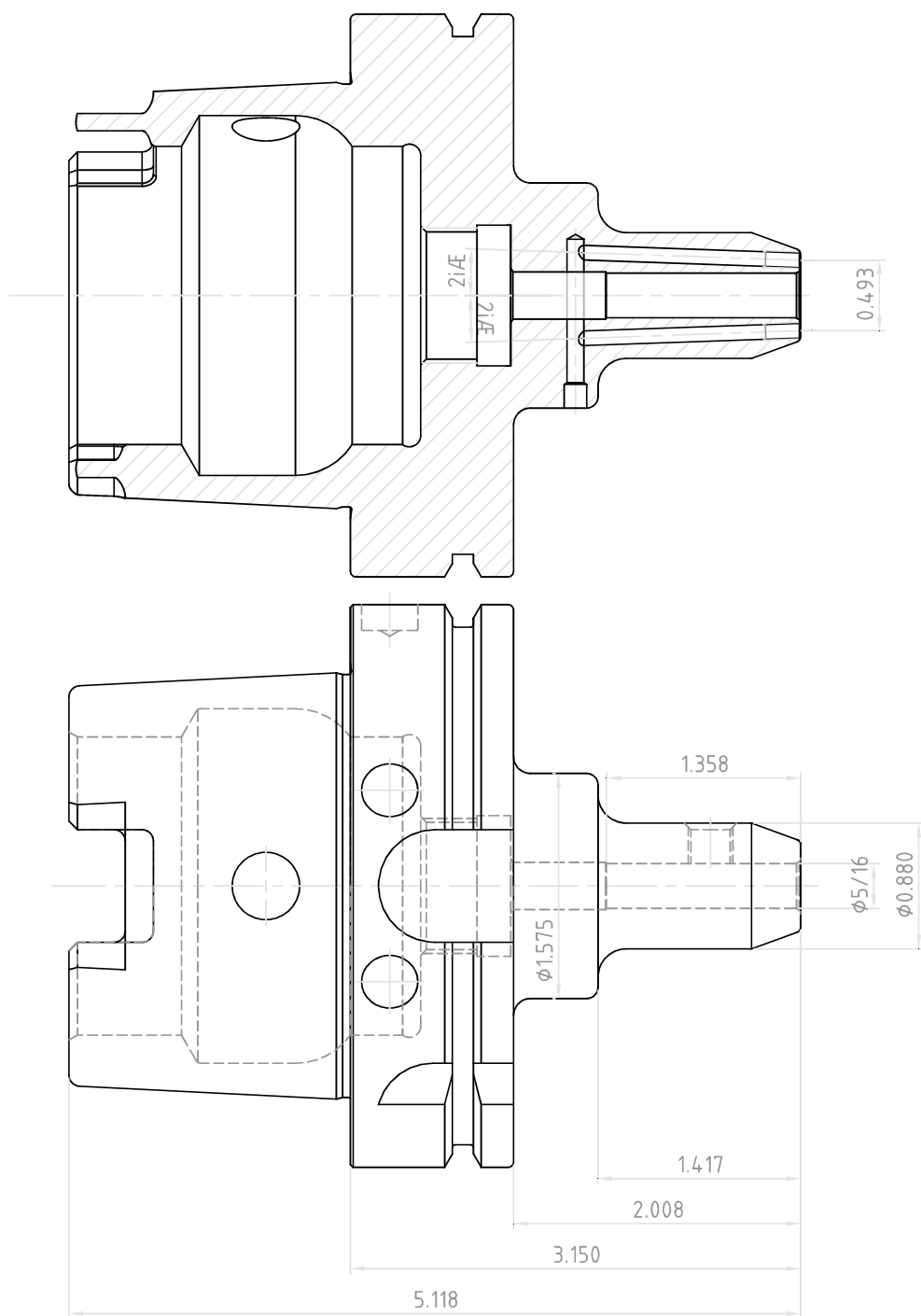

 YG-1 CO., LTD.	DESCRIPTION		
	HSK100A-EMH5/16(7.93)C-3.15(80)		
EDP No.	AR022C	SCALE	1 : 1