

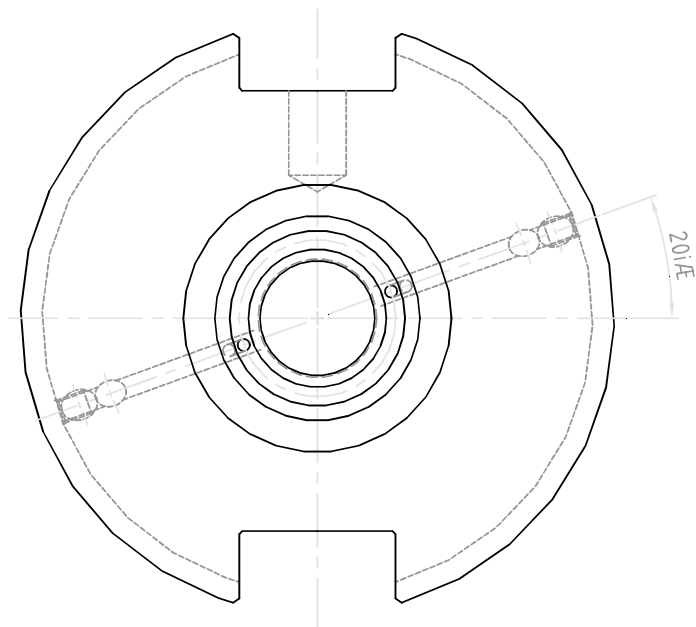

NO.	REVISIONS	DATE	DEVISER
1.			
2.			
3.			

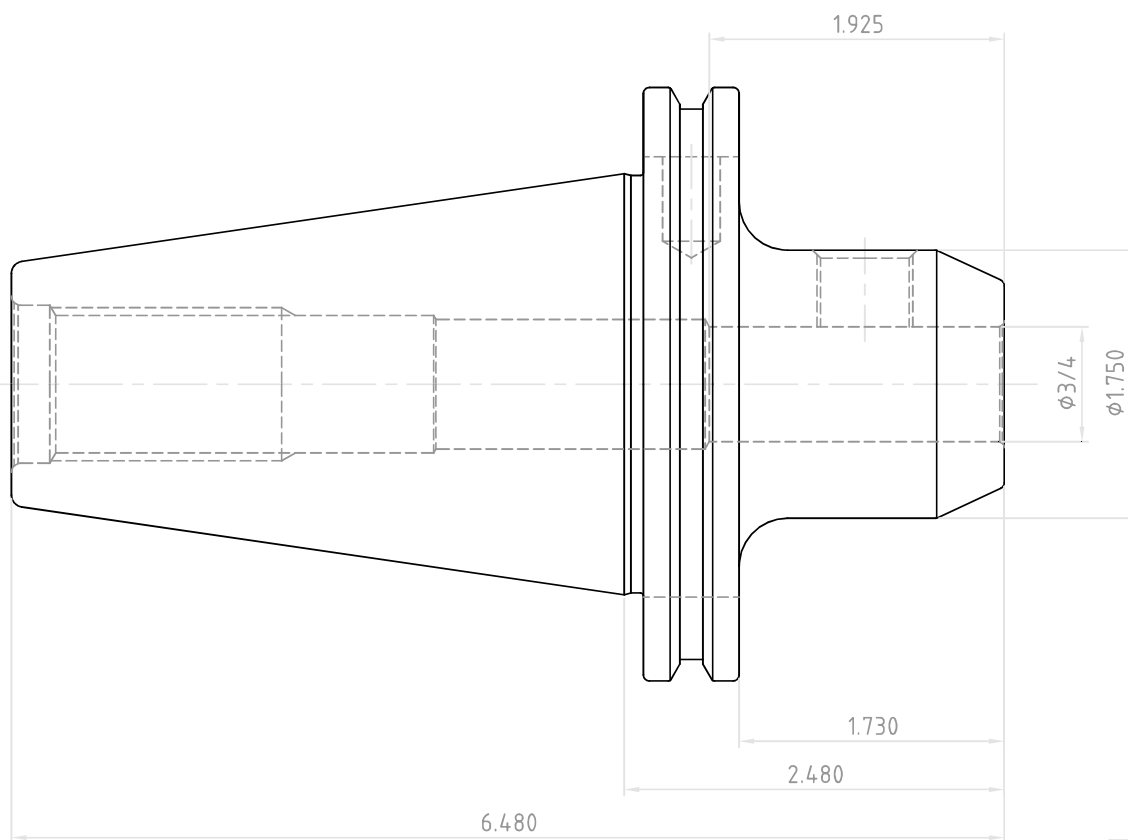
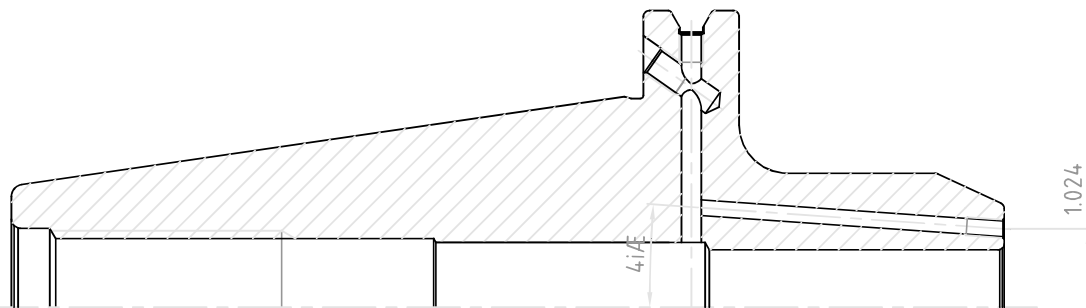

 YG-1 CO., LTD.	DESCRIPTION		
	CAT50AD/B-EMH3/4(19.05)C-2.48(63)		
EDP No.	AL010C	SCALE	1 : 1