

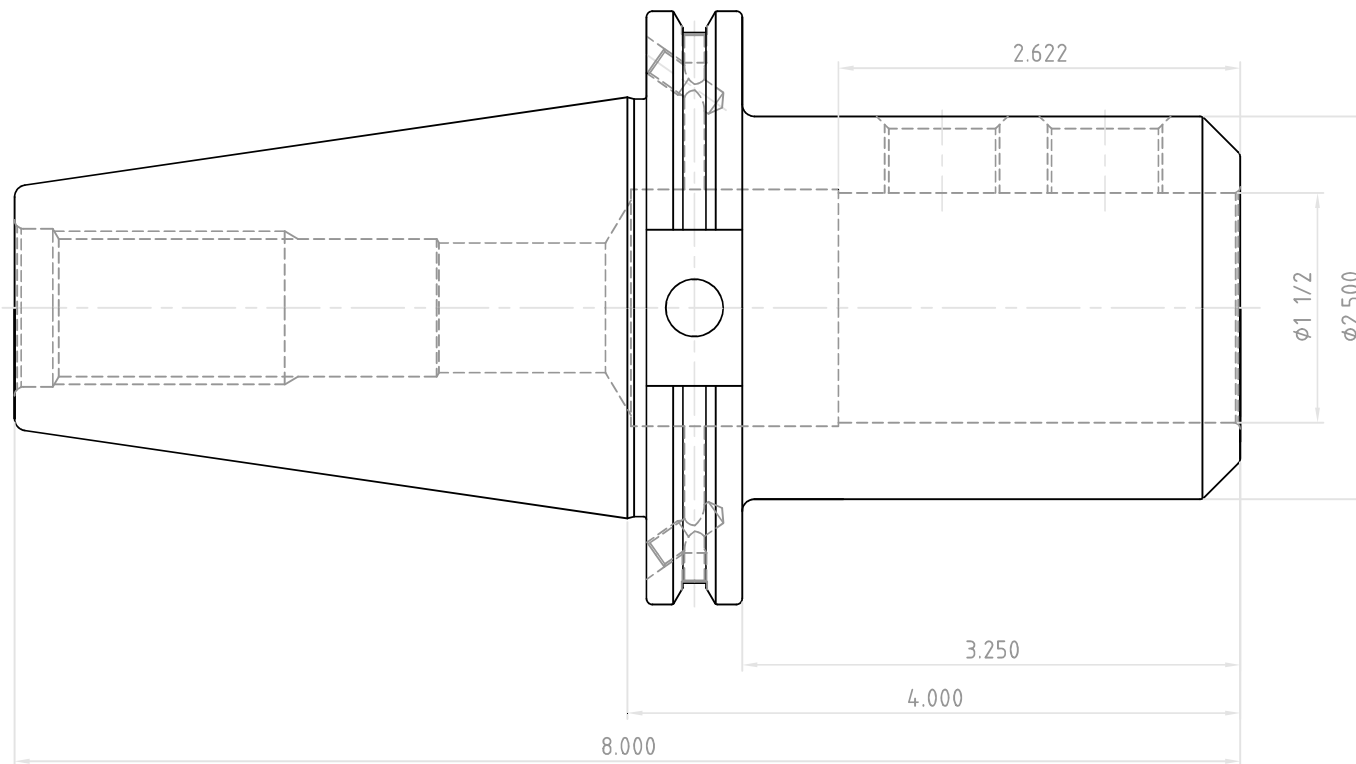

NO.	REVISIONS	DATE	DEVISER
1.			
2.			
3.			



 YG-1 CO., LTD.	DESCRIPTION		
	CAT50AD/B-EMH1 1/2(38.1)-4.00(101.6)		
EDP No.	AL021B	SCALE	1 : 1