

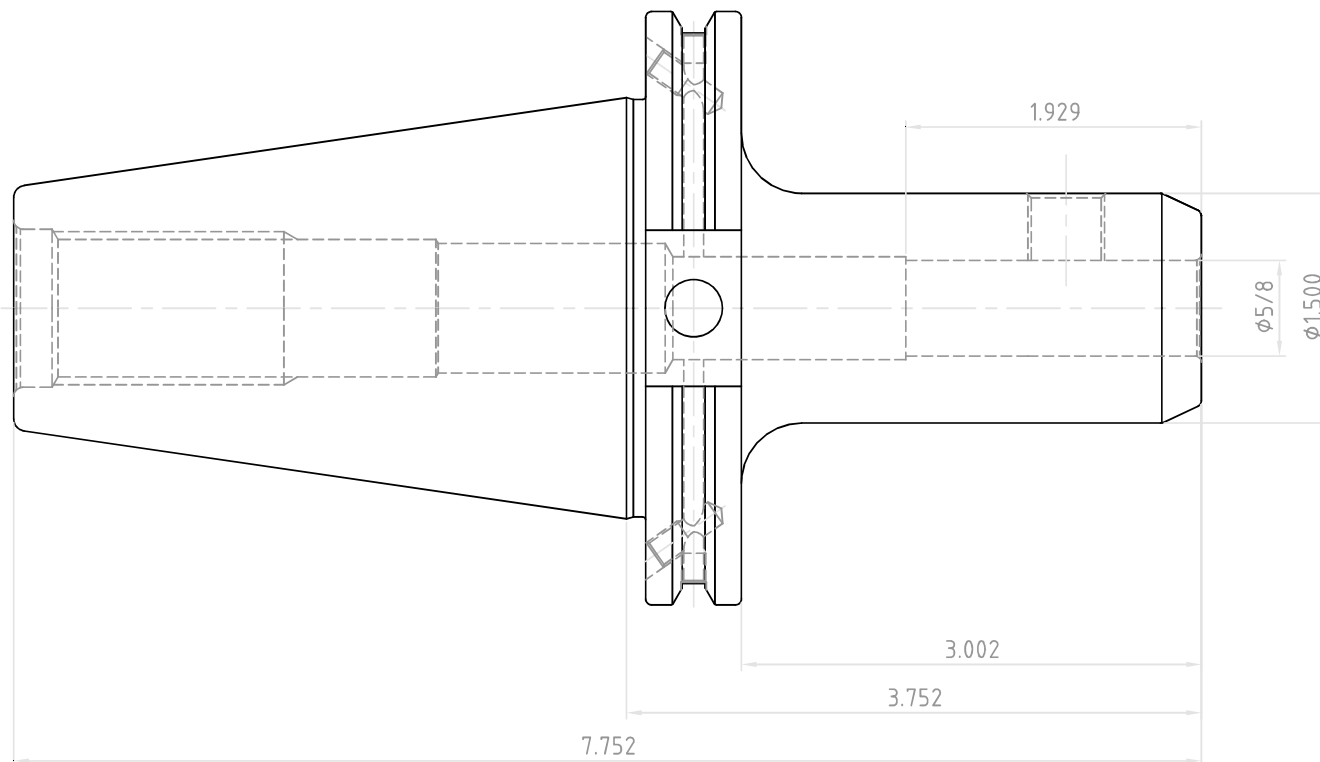

NO.	REVISIONS	DATE	DEVISER
1.			
2.			
3.			



 YG-1 CO., LTD.	DESCRIPTION		
	CAT50AD/B-EMH5/8(15.87)-3.75(95.3)		
EDP No.	AL008B	SCALE	1 : 1