

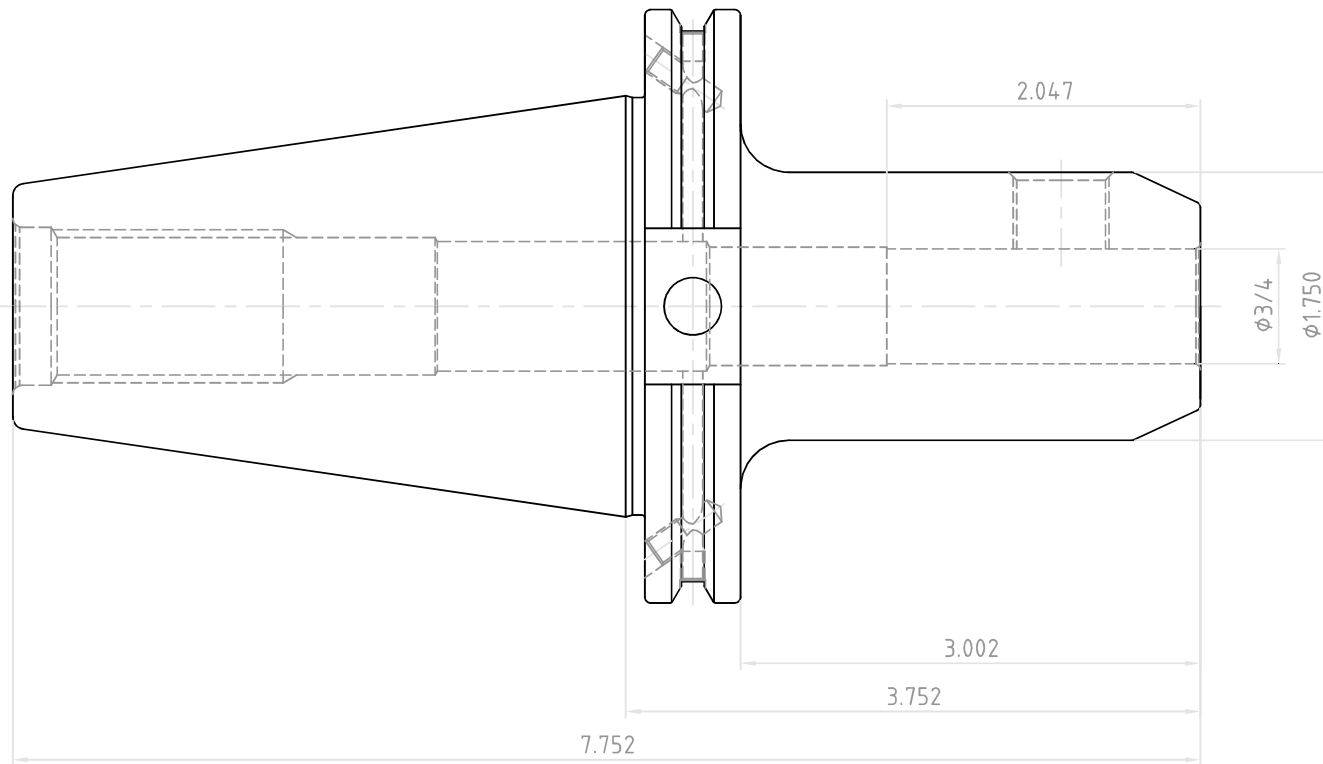

NO.	REVISIONS	DATE	DEVISER
1.			
2.			
3.			



 YG-1 CO., LTD.	DESCRIPTION	
	CAT50AD/B-EMH3/4(19.05)-3.75(95.3)	
EDP No.	AL010B	SCALE 1 : 1