

NO.	REVISIONS	DATE	DEVISER
1.			
2.			
3.			

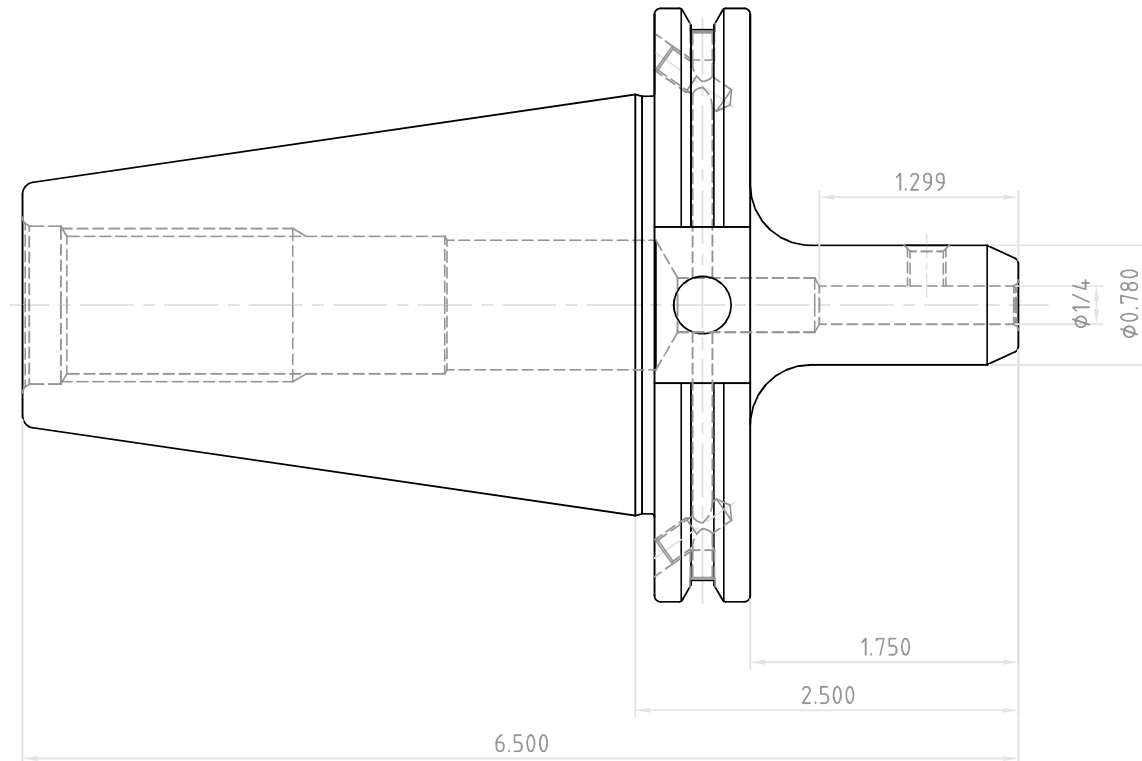

 YG-1 CO., LTD.	DESCRIPTION	
	CAT50AD/B-EMH1/4(6.35)-2.50(63.5)	
EDP No.	AL002B	SCALE 1 : 1