

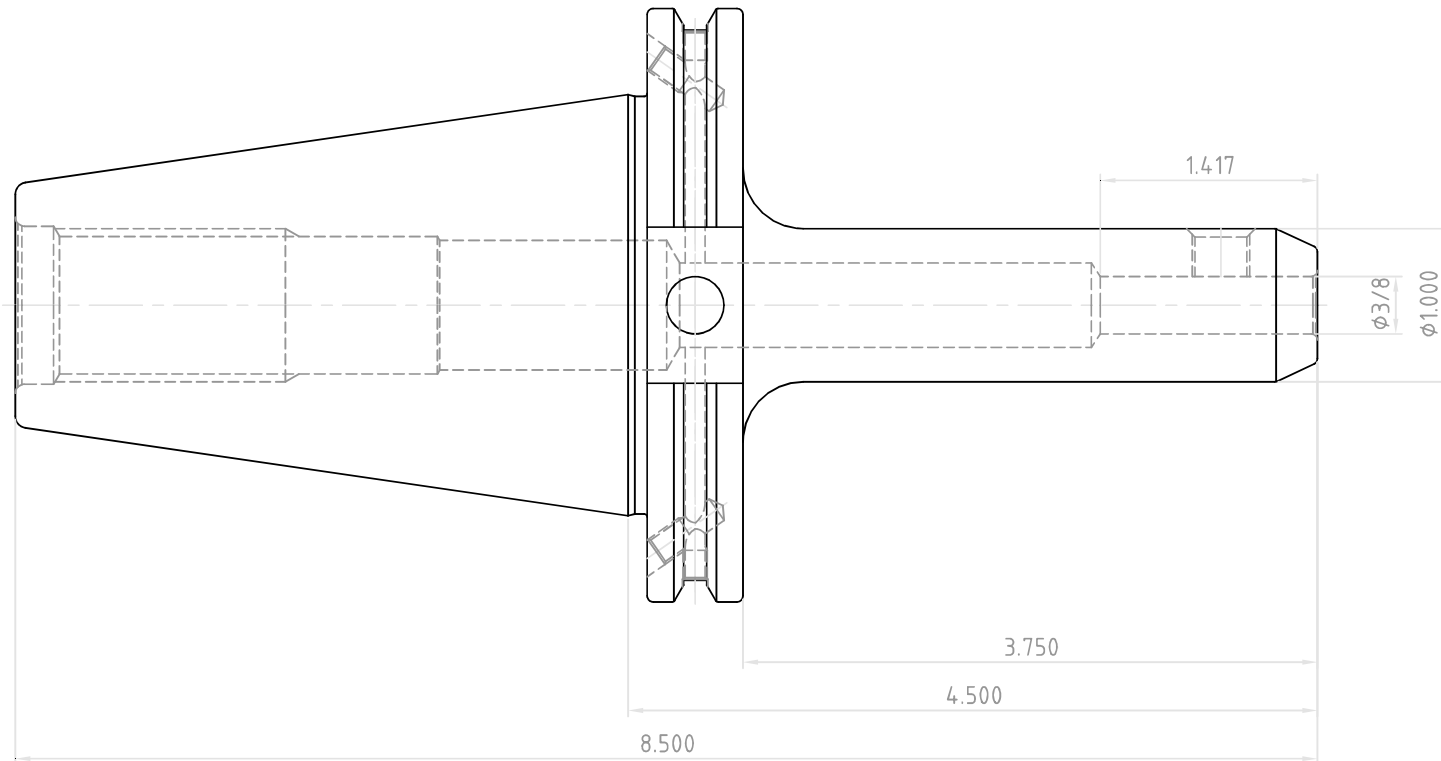

NO.	REVISIONS	DATE	DEVISER
1.			
2.			
3.			



 YG-1 CO., LTD.	DESCRIPTION	
	CAT50AD/B-EMH3/8(9.52)-4.50(114.3)	
	EDP No.	AL104B SCALE 1 : 1