

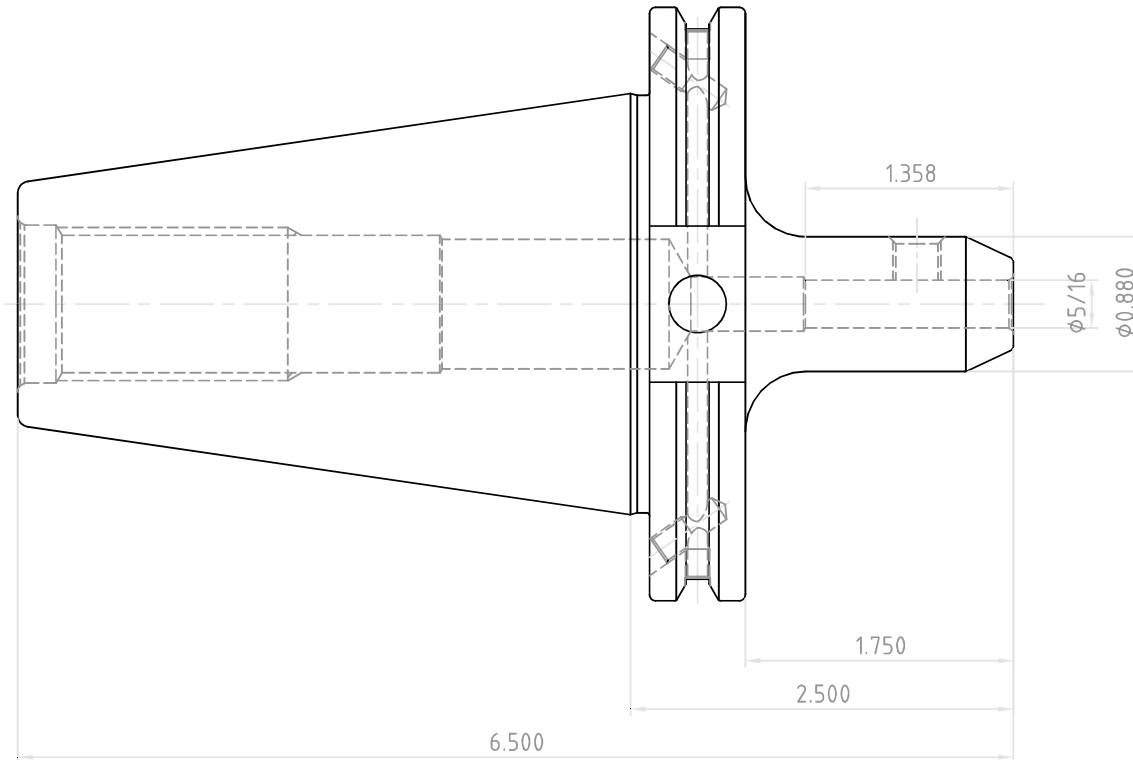

NO.	REVISIONS	DATE	DEVISER
1.			
2.			
3.			



 YG-1 CO., LTD.	DESCRIPTION	
	CAT50AD/B-EMH5/16(7.93)-2.50(63.5)	
EDP No.	AL003B	SCALE 1 : 1