

NO.	REVISIONS	DATE	DEVISER
1.			
2.			
3.			

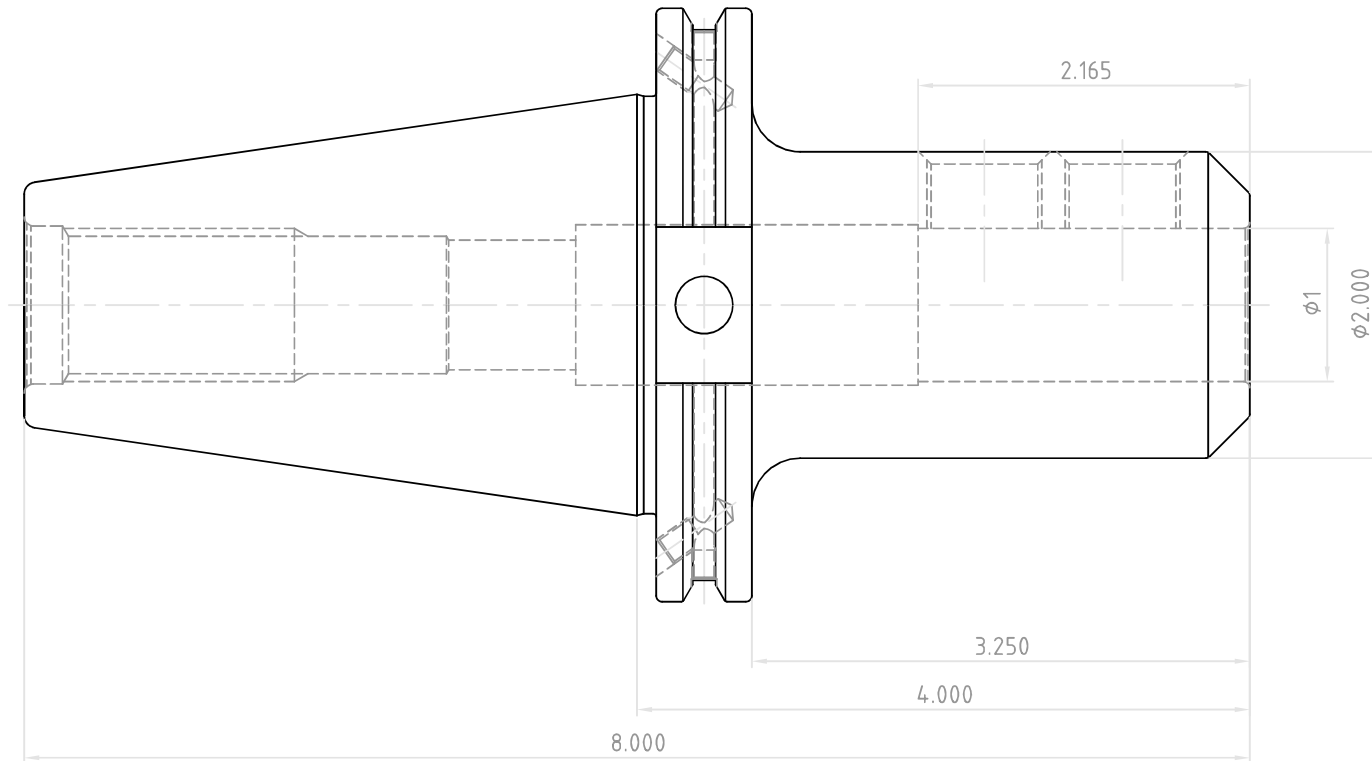

 YG-1 CO., LTD.	DESCRIPTION	
	CAT50AD/B-EMH1(25.4)-4.00(101.6)	
	EDP No.	AL014B
	SCALE	1 : 1