

NO.	REVISIONS	DATE	DEVISER
1.			
2.			
3.			

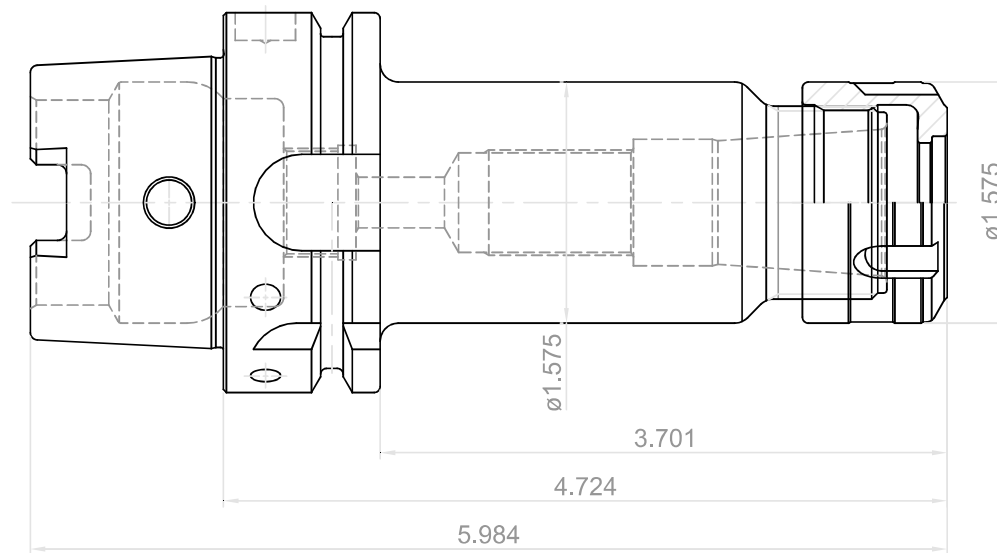

 YG-1 CO., LTD.	DESCRIPTION	
	HSK63A-SKA16-4.72(120)	
EDP No.	TQ106	SCALE 1 : 1