

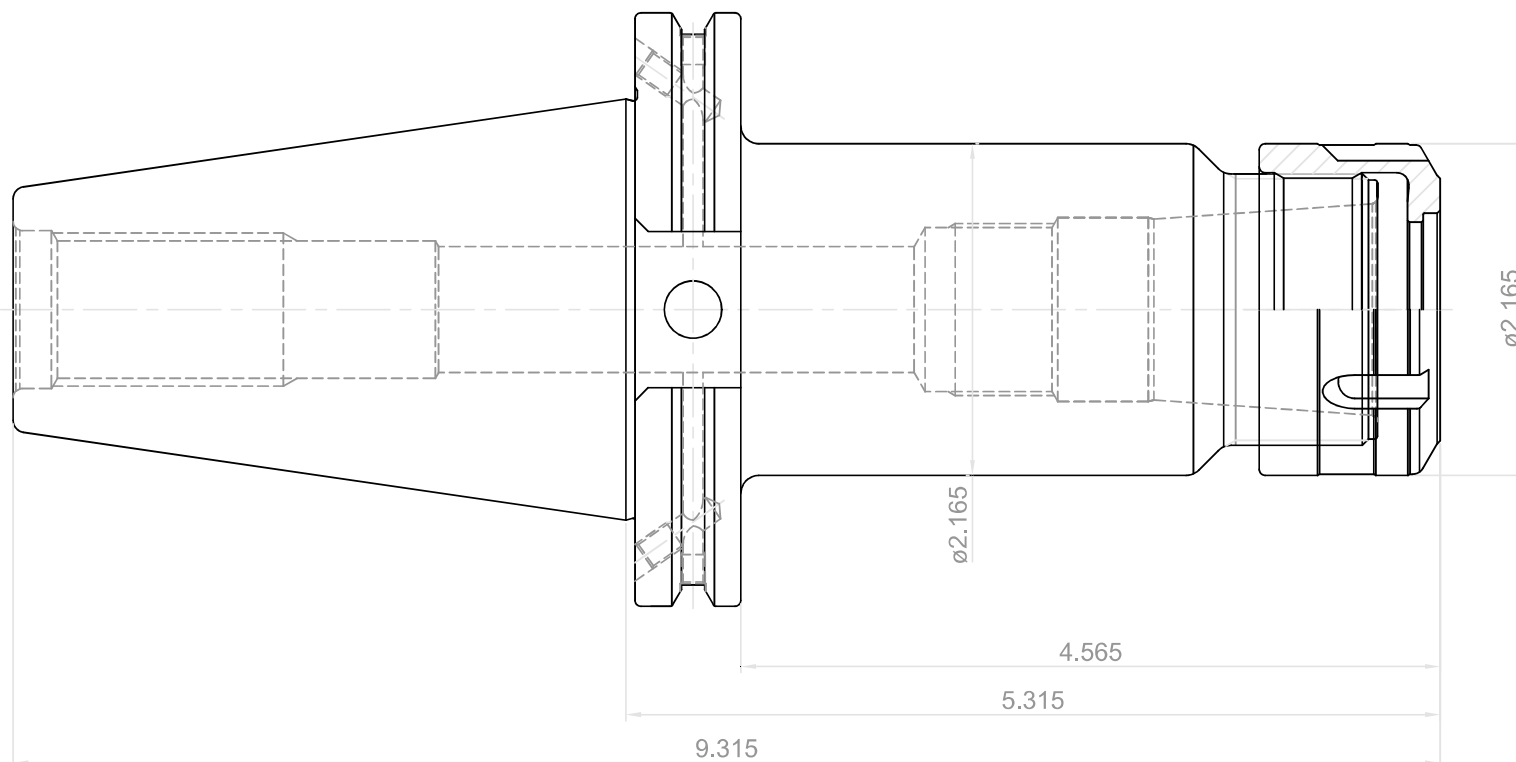

NO.	REVISIONS	DATE	DEVISER
1.			
2.			
3.			



 YG-1 CO., LTD.

DESCRIPTION

CCT50AD/B-SKA25-5.31(135)

EDP No. TC041 SCALE 1 : 1