

NO.	REVISIONS	DATE	DEVISER
1.			
2.			
3.			

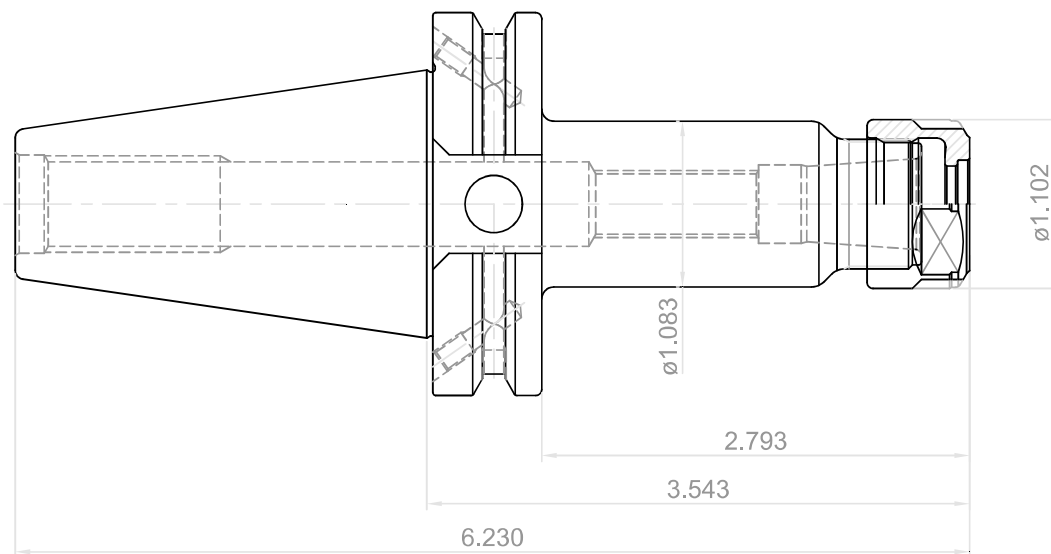

 YG-1 CO., LTD.	DESCRIPTION	
	CCT40AD/B-SKA10-3.54(90)	
	EDP No.	TB023
	SCALE	1 : 1