

NO.	REVISIONS	DATE	DEVISER
1.			
2.			
3.			

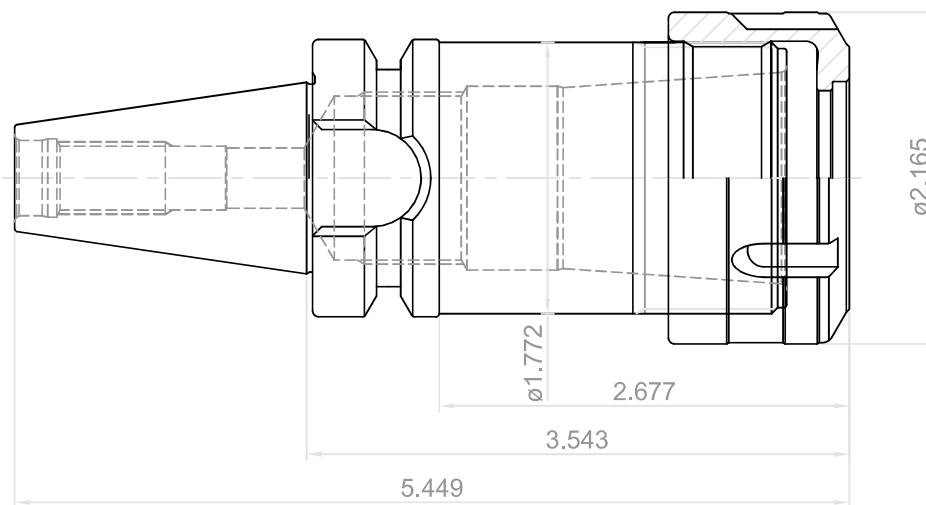

 YG-1 CO., LTD.	DESCRIPTION	
	CBT30-SKA25-3.54(90)	
EDP No.	TD120	SCALE 1 : 1