

NO.	REVISIONS	DATE	DEVISER
1.			
2.			
3.			

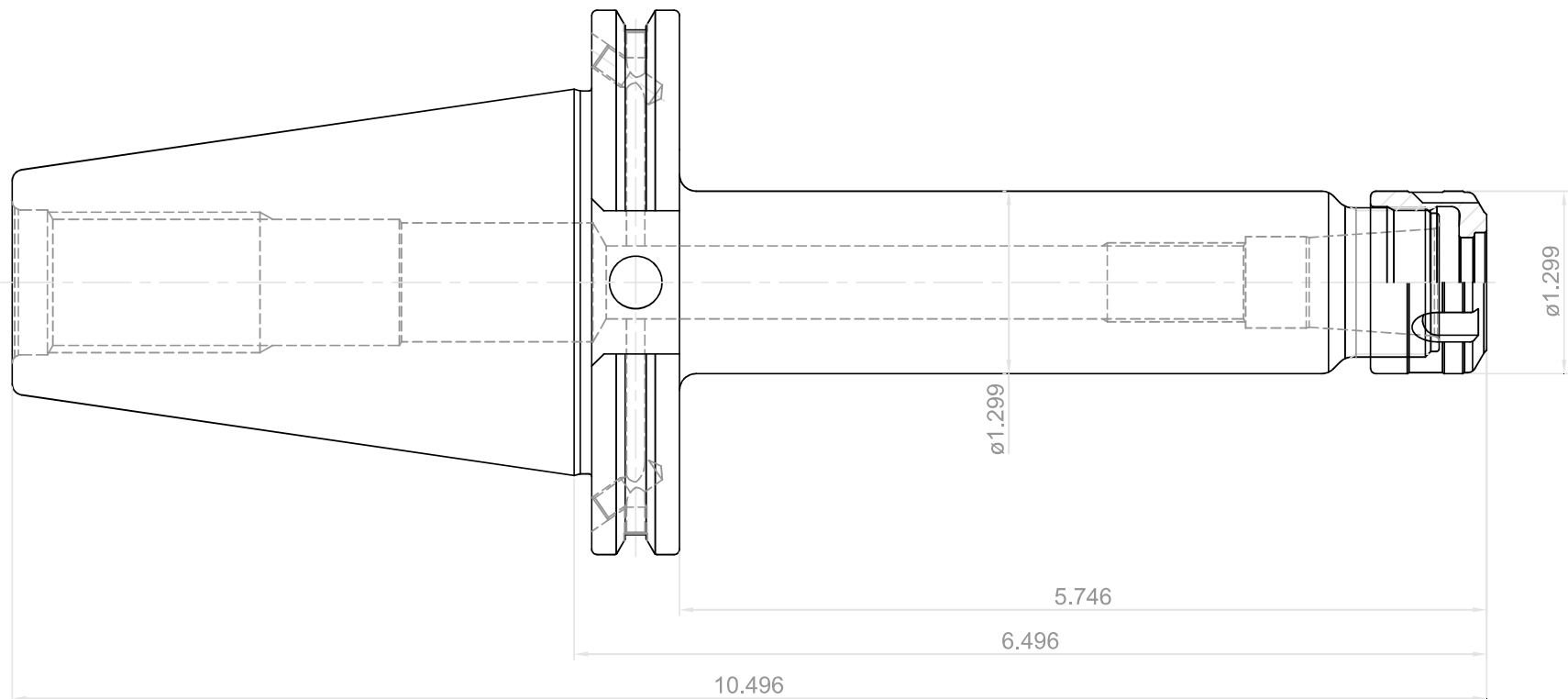

 YG-1 CO., LTD.	DESCRIPTION	
	CAT50AD/B-SKA13-6.50(165)	
EDP No.	TL030	SCALE 1 : 1