

NO.	REVISIONS	DATE	DEVISER
1.			
2.			
3.			

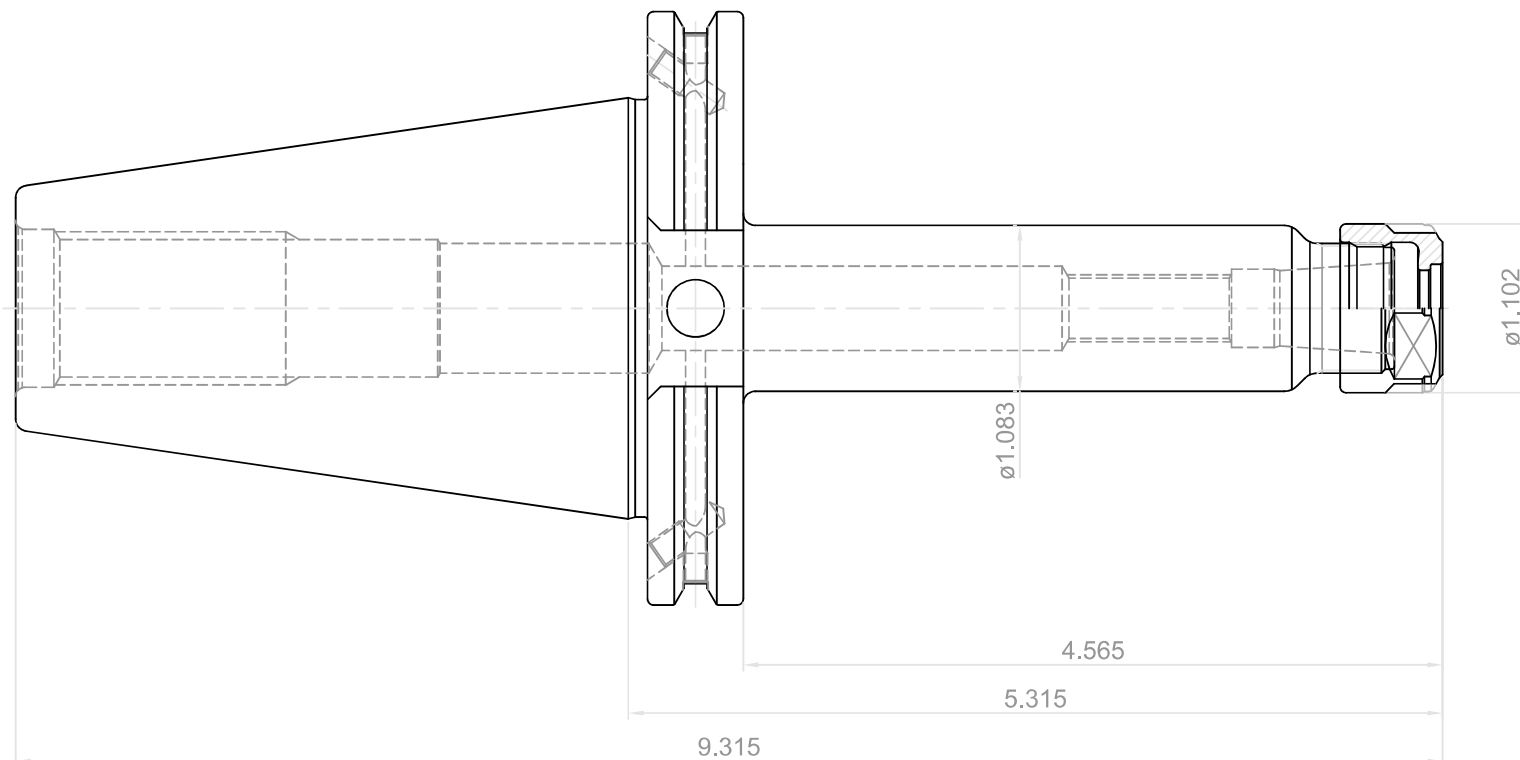

 YG-1 CO., LTD.	DESCRIPTION	
	CAT50AD/B-SKA10-5.31(135)	
EDP No.	TL025	SCALE 1 : 1