

NO.	REVISIONS	DATE	DEVISER
1.			
2.			
3.			

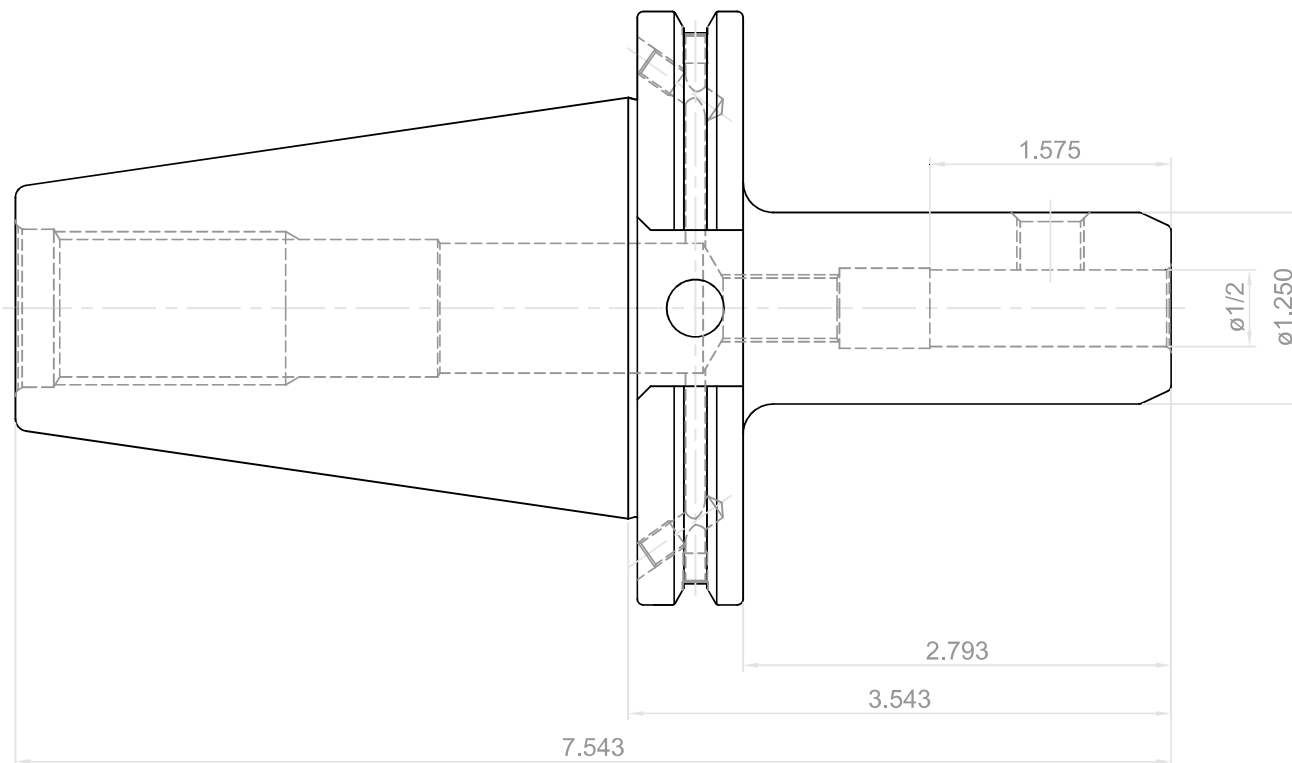

 YG-1 CO., LTD.	DESCRIPTION	
	CCT50AD/B-SLA1/2(12.7)-3.54(90)	
EDP No.	AC026	SCALE 1 : 1