

NO.	REVISIONS	DATE	DEVISER
1.			
2.			
3.			

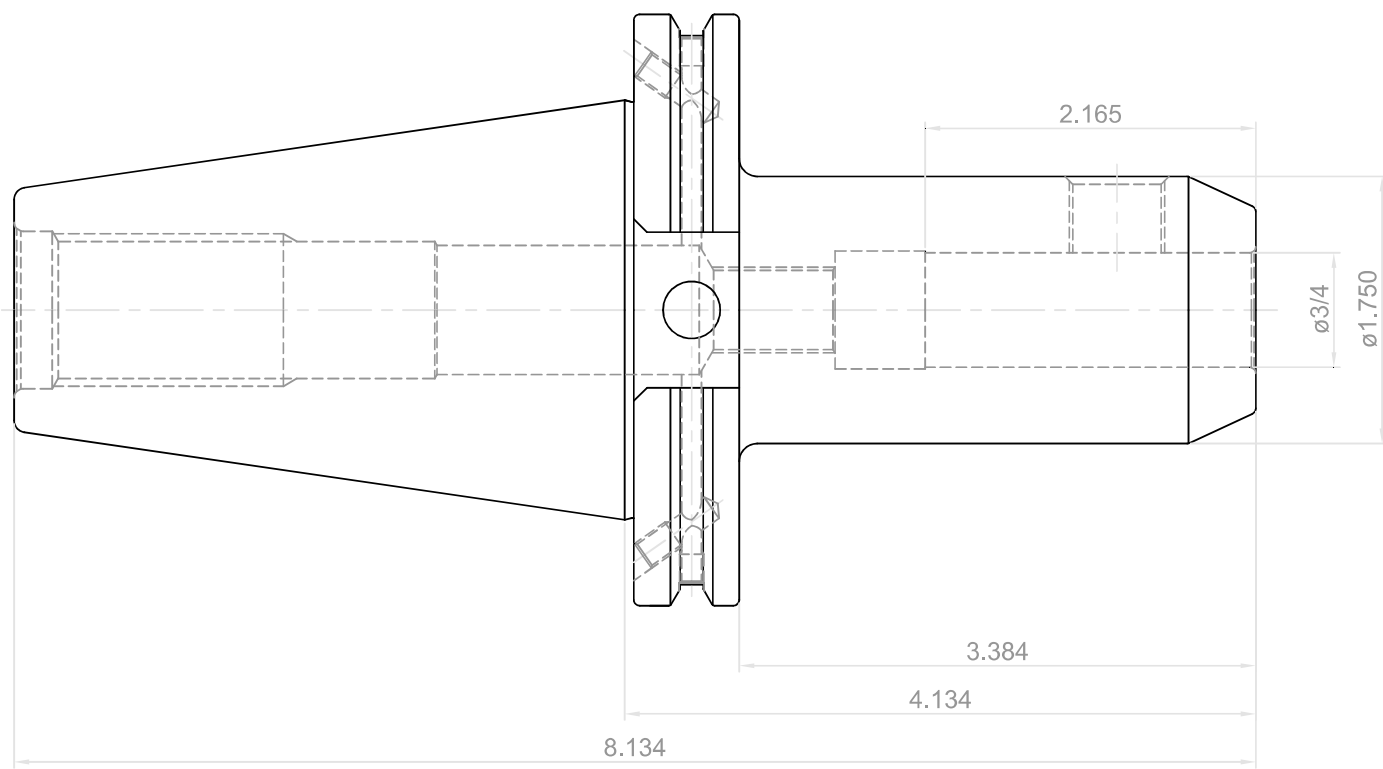

 YG-1 CO., LTD.	DESCRIPTION		
	CCT50AD/B-SLA3/4(19.05)-4.13(105)		
EDP No.	AC030	SCALE	1 : 1