

NO.	REVISIONS	DATE	DEVISER
1.			
2.			
3.			

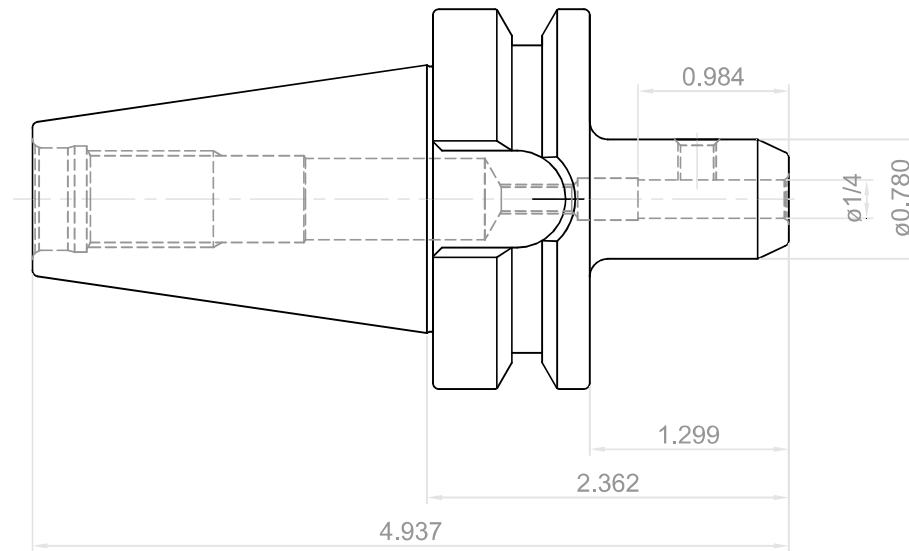

 YG-1 CO., LTD.	DESCRIPTION	
	CBT40-SLA1/4(6.35)-2.36(60)	
EDP No.	AE020	SCALE 1 : 1