

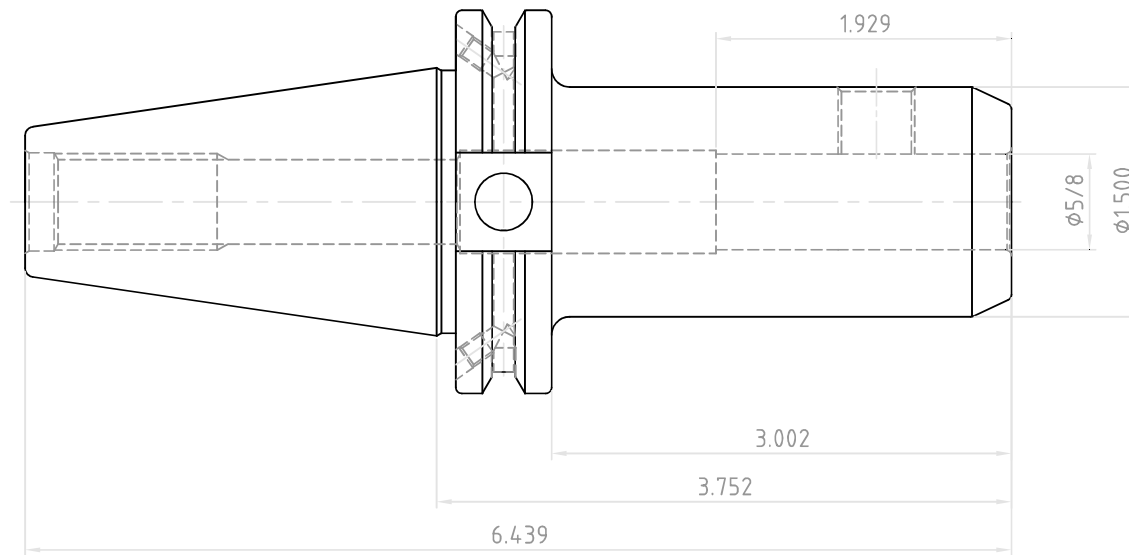

NO.	REVISIONS	DATE	DEVISER
1.			
2.			
3.			



 YG-1 CO., LTD.	DESCRIPTION		
	CAT40AD/B-EMH5/8(15.87)-3.75(95.3)		
	EDP No.	AK008B	SCALE 1 : 1