

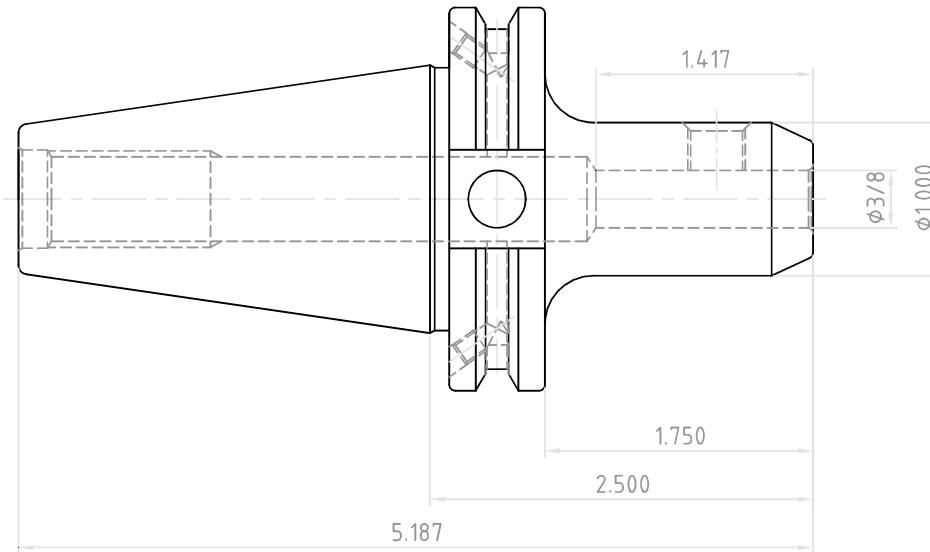

NO.	REVISIONS	DATE	DEVISER
1.			
2.			
3.			



 YG-1 CO., LTD.	DESCRIPTION	
	CAT40AD/B-EMH3/8(9.52)-2.50(63.5)	
	EDP No.	AK004B
	SCALE	1 : 1