

NO.	REVISIONS	DATE	DEVISER
1.			
2.			
3.			

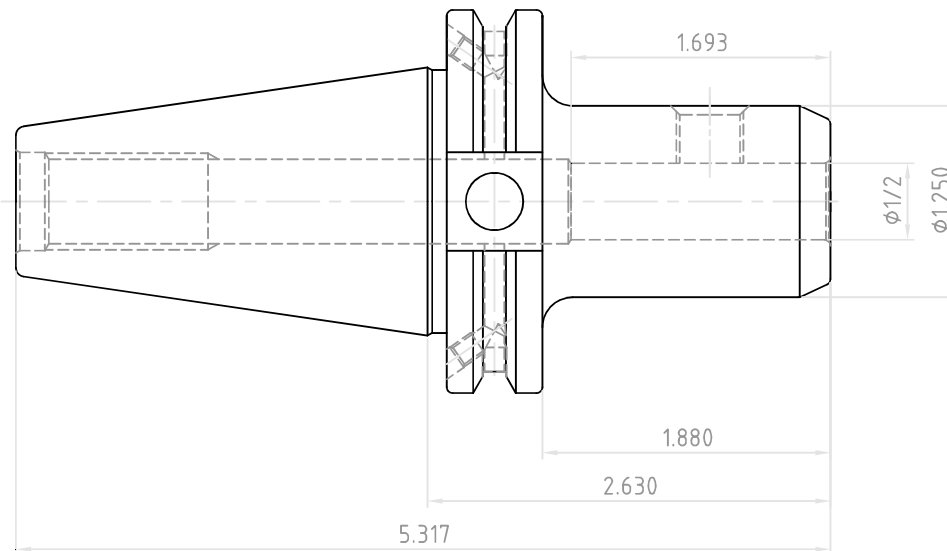

 YG-1 CO., LTD.	DESCRIPTION	
	CAT40AD/B-EMH1/2(12.7)-2.63(66.8)	
	EDP No.	AK006B
	SCALE	1 : 1