

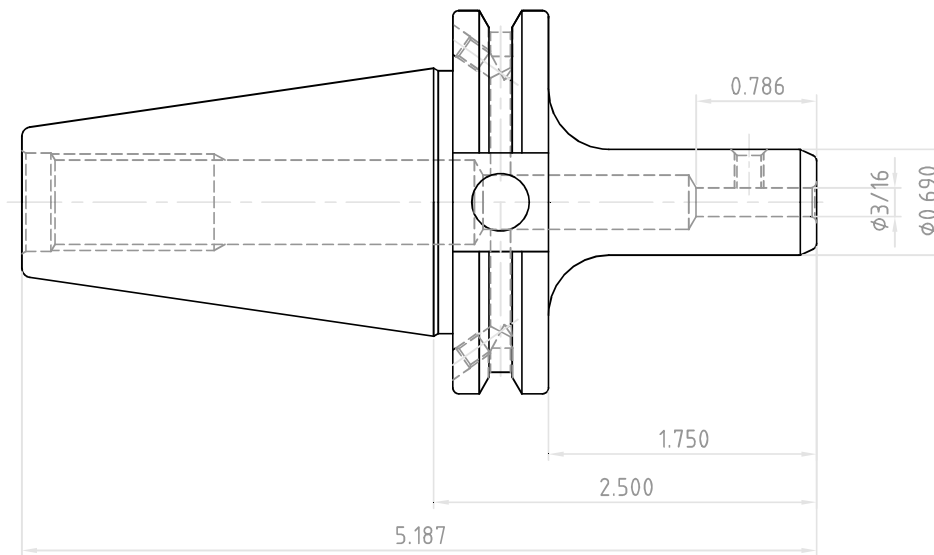

NO.	REVISIONS	DATE	DEVISER
1.			
2.			
3.			



 YG-1 CO., LTD.	DESCRIPTION	
	CAT40AD/B-EMH3/16(4.76)-2.50(63.5)	
EDP No.	AK001B	SCALE 1 : 1