

NO.	REVISIONS	DATE	DEVISER
1.			
2.			
3.			

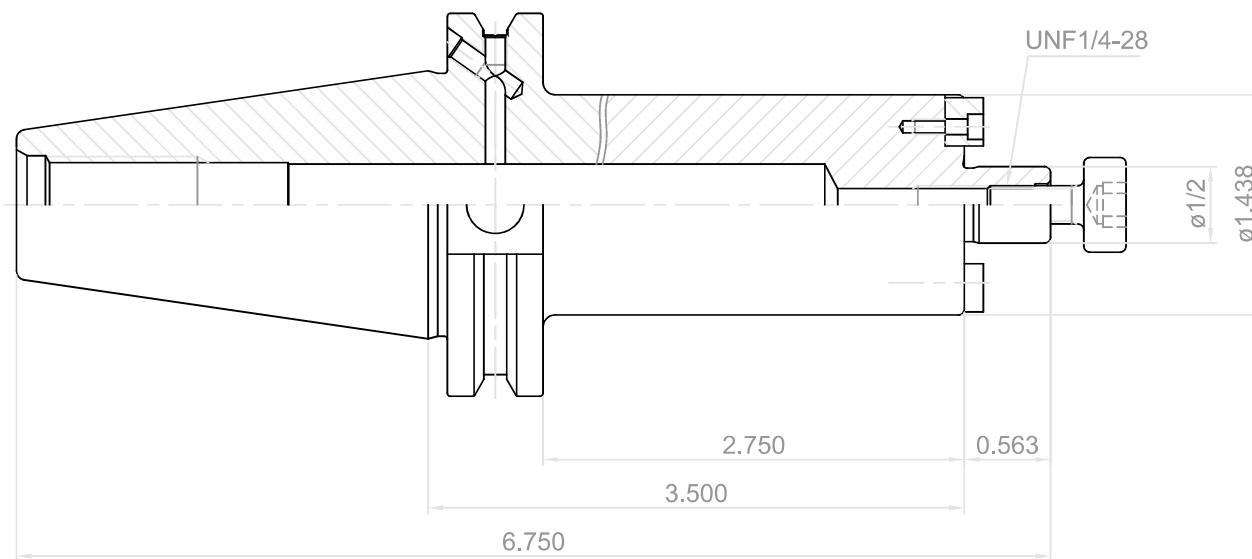

 YG-1 CO., LTD.	DESCRIPTION	
	CAT40AD/B-SMA1/2(12.7)-3.50(88.9)	
EDP No.	EK306B	SCALE 1 : 1