

NO.	REVISIONS	DATE	DEVISER
1.			
2.			
3.			

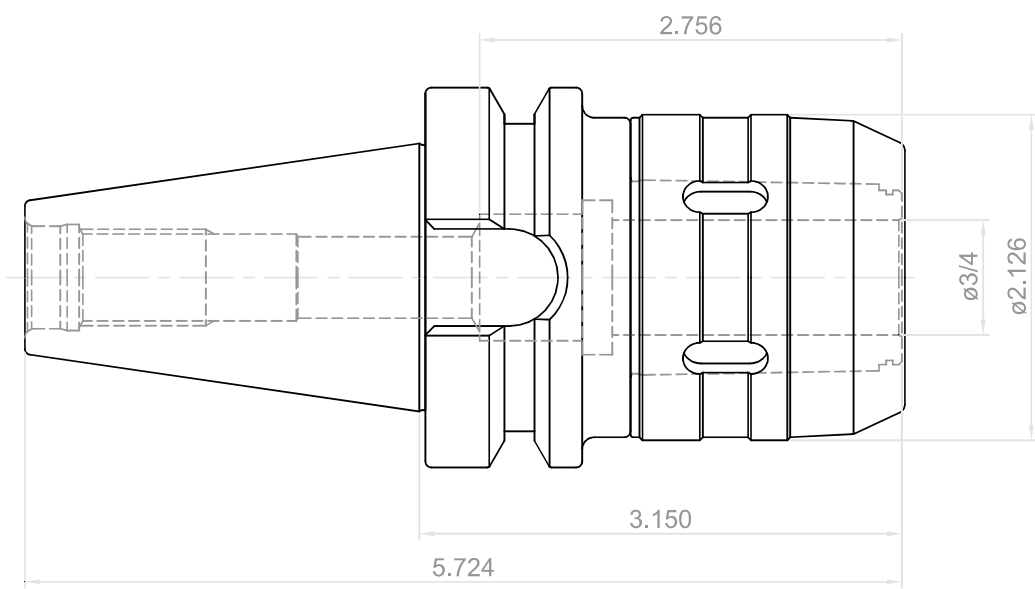

 YG-1 CO., LTD.	DESCRIPTION	
	CBT40-C3/4(19.05)-3.15(80)HS	
EDP No.	LE020	SCALE 1 : 1