

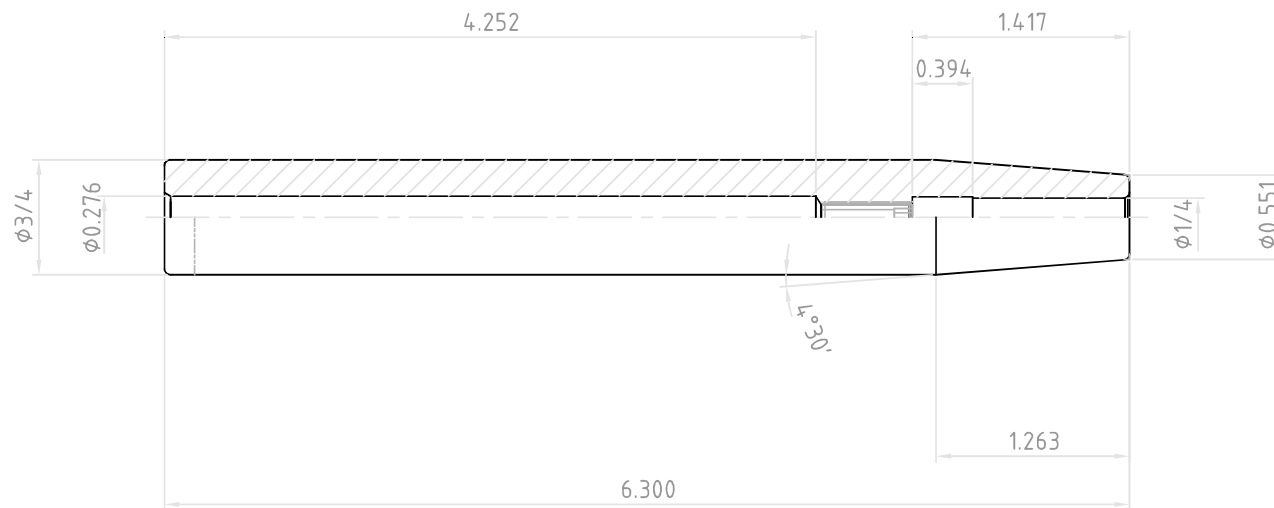

NO.	REVISIONS	DATE	DEVISER
1.			
2.			
3.			



 YG-1 CO., LTD.	SSK CONTROL NUMBER		
	ST3/4(19.05)-SFH1/4(6.35)-6.30(160)		
	EDP No.	VS032	SCALE 1 : 1