

NO.	REVISIONS	DATE	DEVISER
1.			
2.			
3.			

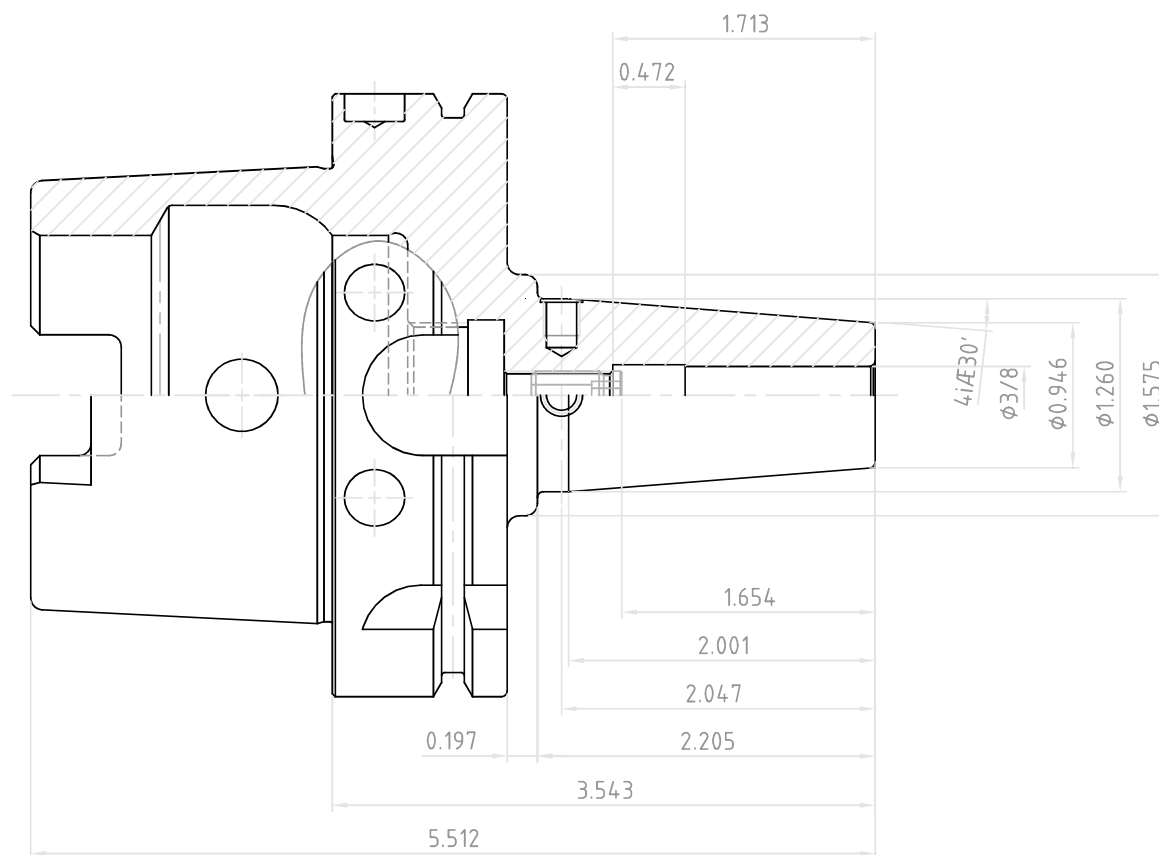

	SSK CONTROL NUMBER	
	HSK100A-SFH3/8(9.525)-3.543(90)	
EDP No.	VR024	SCALE 1 : 1