

NO.	REVISIONS	DATE	DEVISER
1.			
2.			
3.			

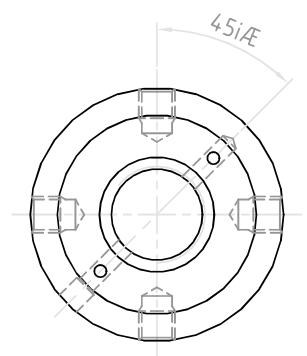
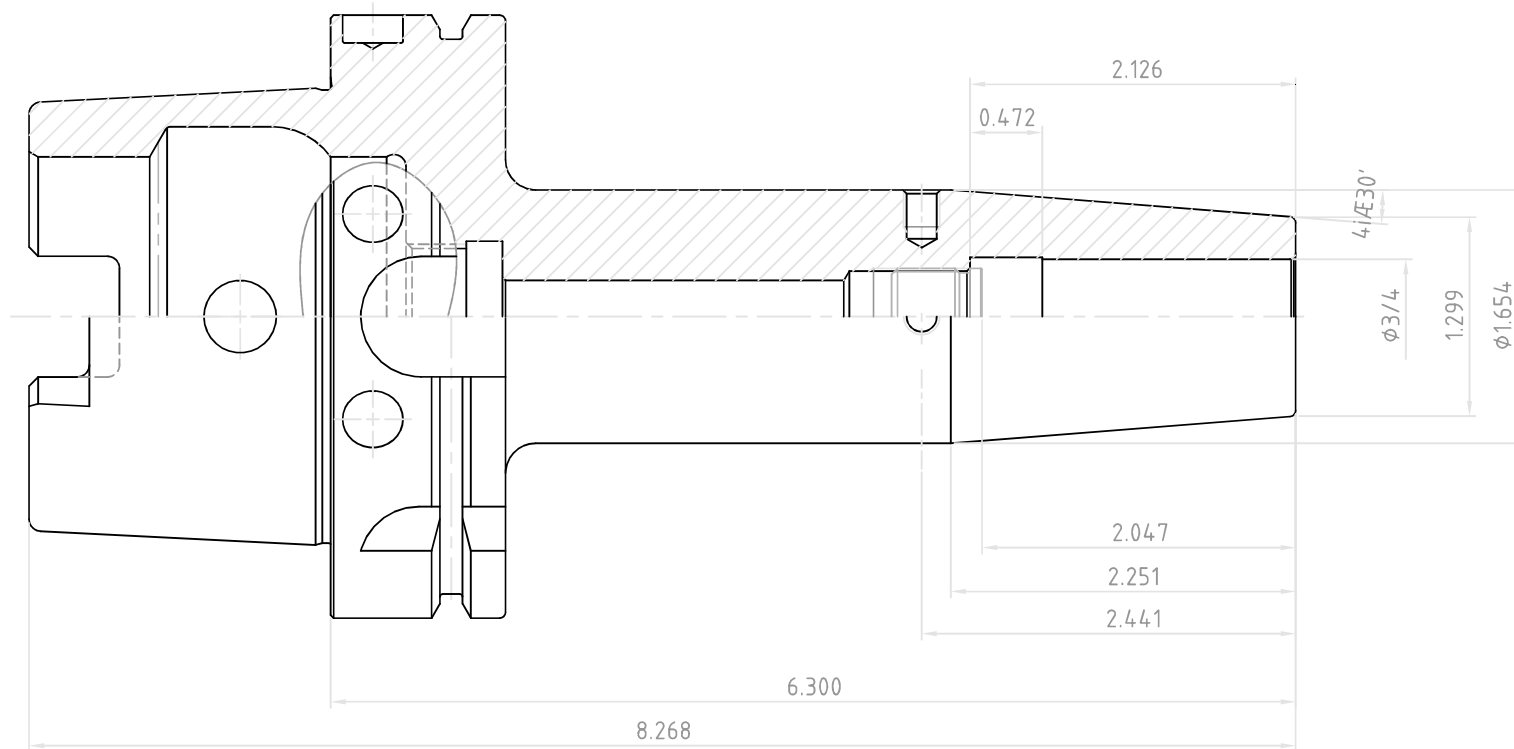
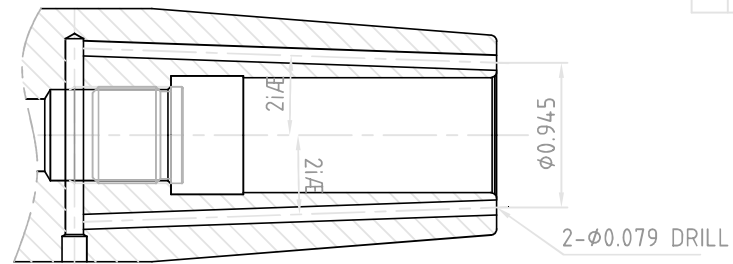

 YG-1 CO., LTD.	SSK CONTROL NUMBER		
	HSK100A-SFH3/4(19.050)C-6.300(160)		
EDP No.	VR038J	SCALE	1 : 1