

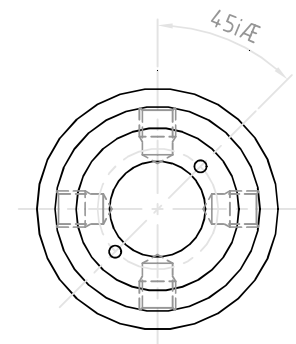

NO.	REVISIONS	DATE	DEVISER
1.			
2.			
3.			

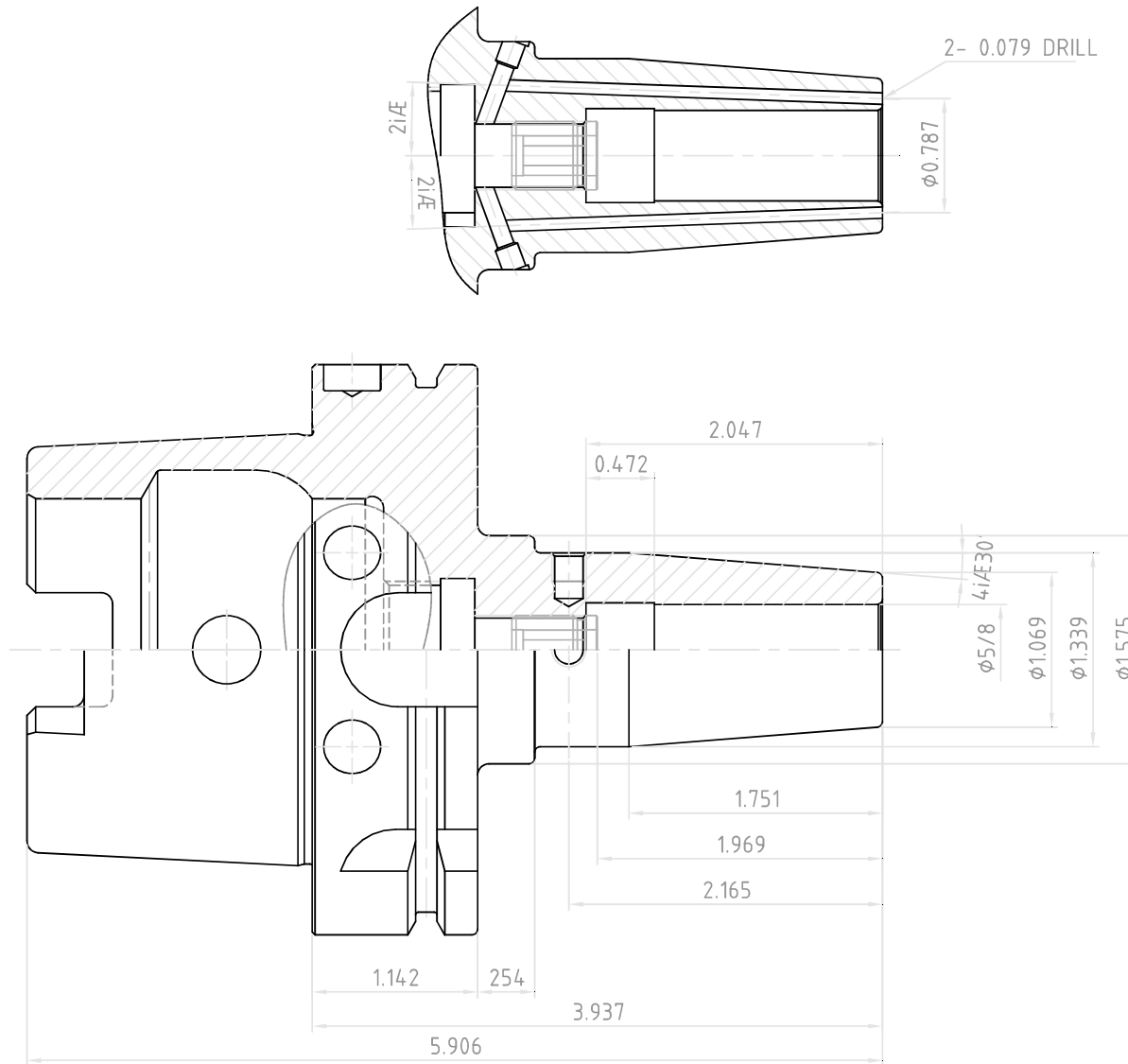

 YG-1 CO., LTD.	SSK CONTROL NUMBER		
	HSK100A-SFH5/8(15.875)C-3.937(100)		
EDP No.	VR032J	SCALE	1 : 1