

NO.	REVISIONS	DATE	DEVISER
1.			
2.			
3.			

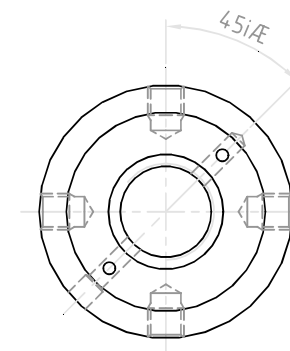
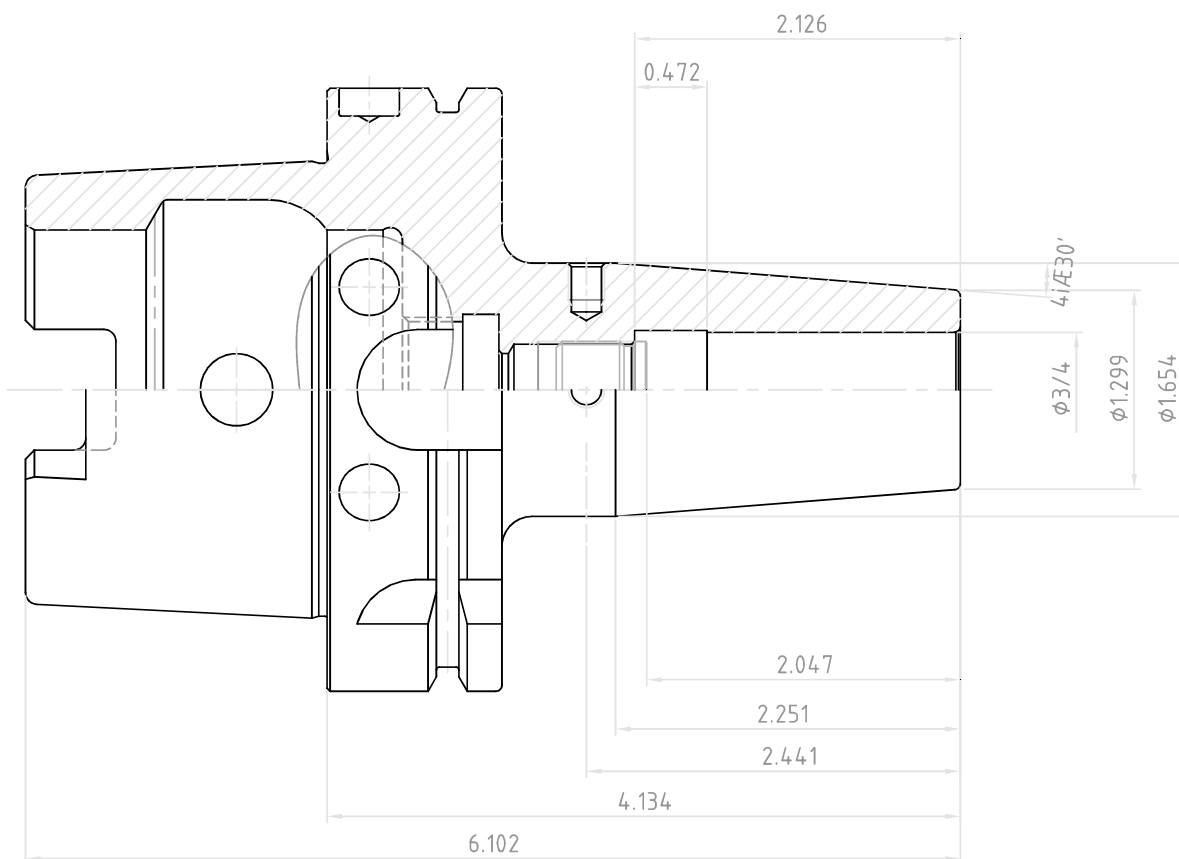
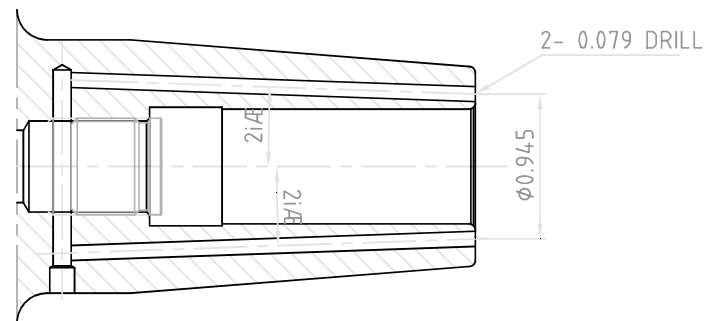

 YG-1 CO., LTD.	SSK CONTROL NUMBER		
	HSK100A-SFH3/4(19.050)C-4.134(105)		
	EDP No.	VR036J	SCALE 1 : 1