

NO.	REVISIONS	DATE	DEVISER
1.			
2.			
3.			

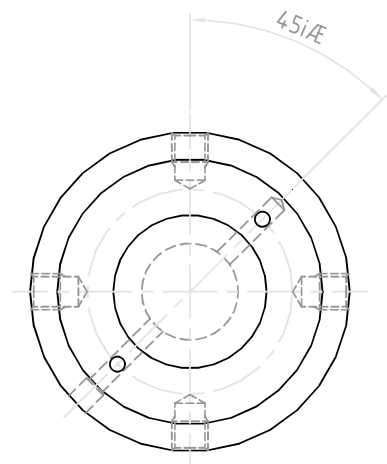
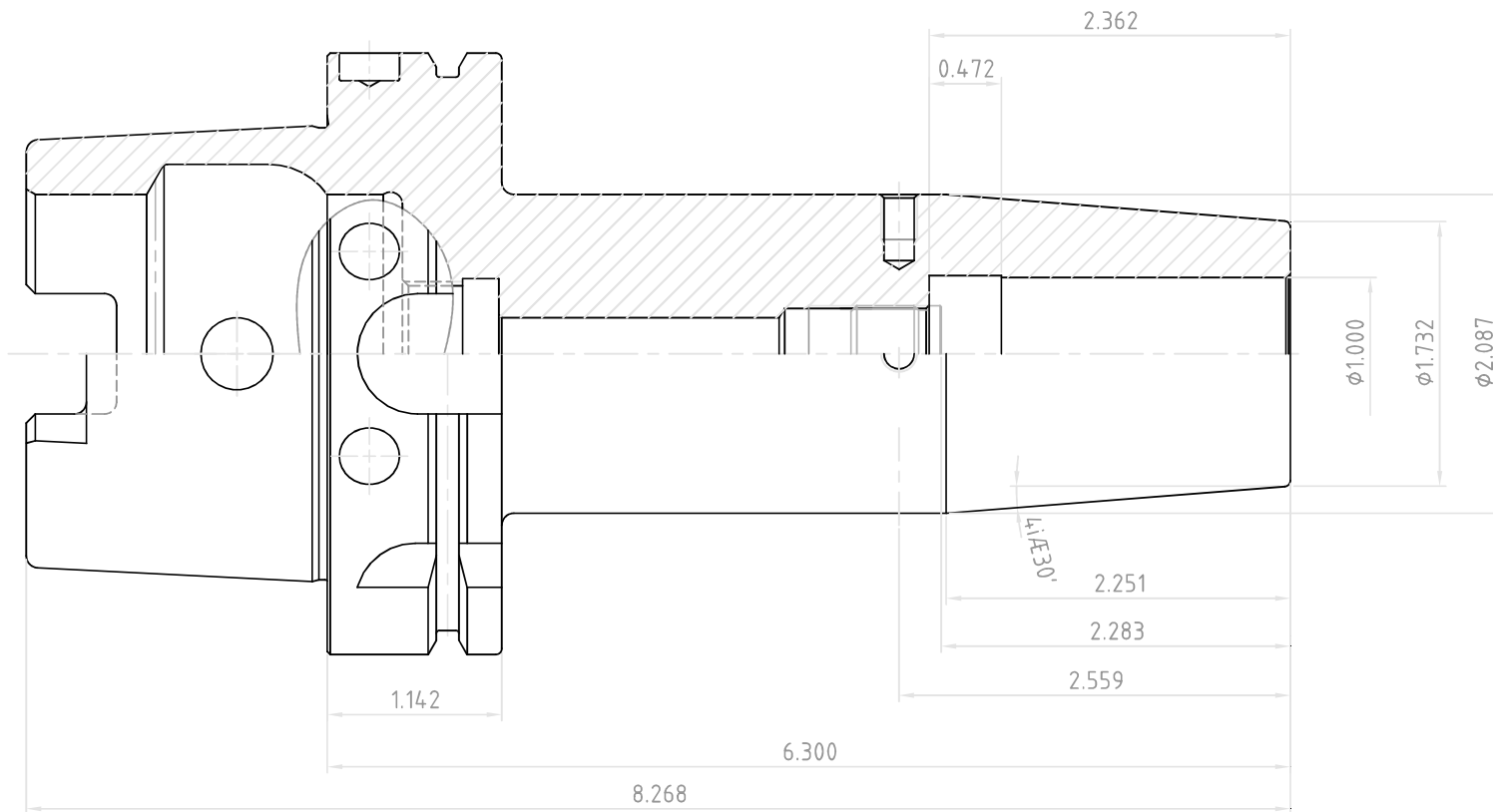
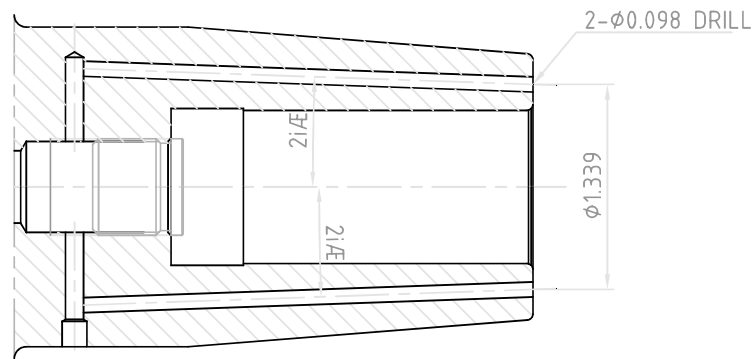

YG-1 CO., LTD.

SSK CONTROL NUMBER

HSK100A-SFH1.000(25.40)C-6.300(160)

EDP No.

VR042J

SCALE 1 : 1