

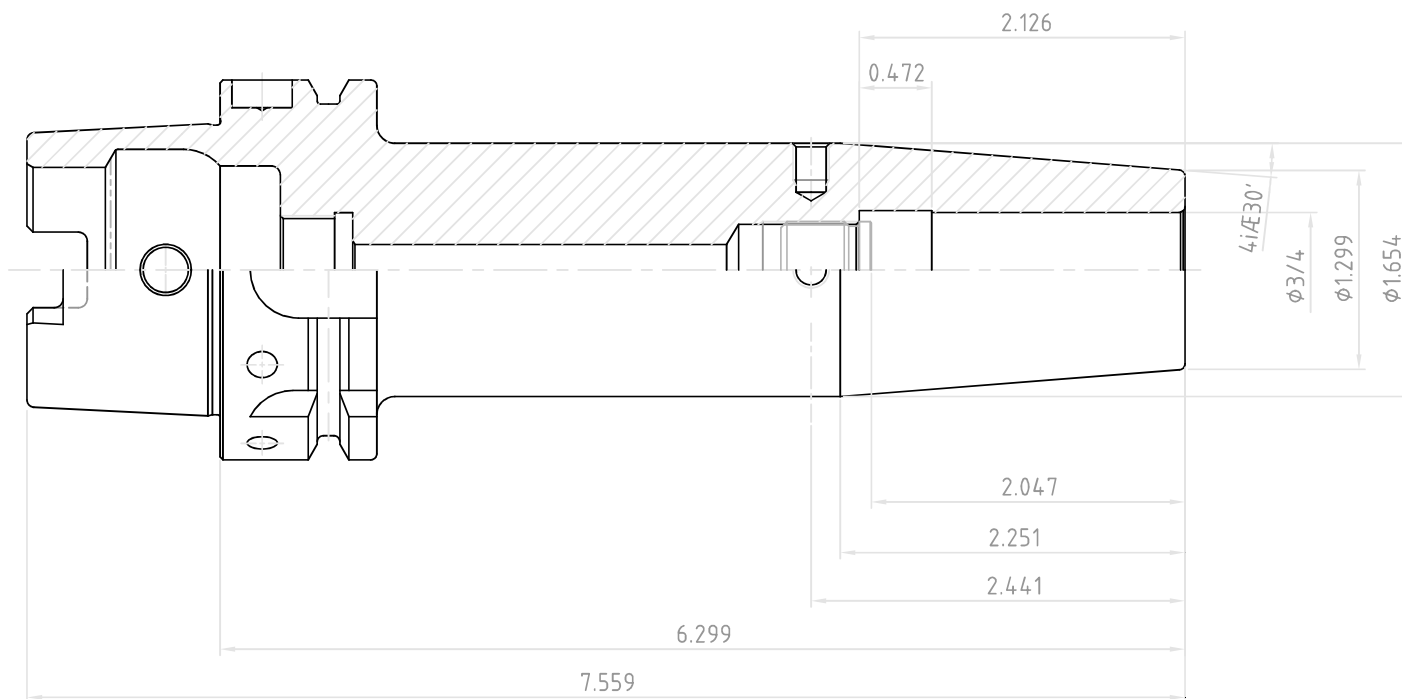

NO.	REVISIONS	DATE	DEVISER
1.			
2.			
3.			



 YG-1 CO., LTD.	SSK CONTROL NUMBER		
	HSK63A-SFH3/4(19.050)-6.300(160)		
	EDP No.	VQ042	SCALE 1 : 1