

NO.	REVISIONS	DATE	DEVISER
1.			
2.			
3.			

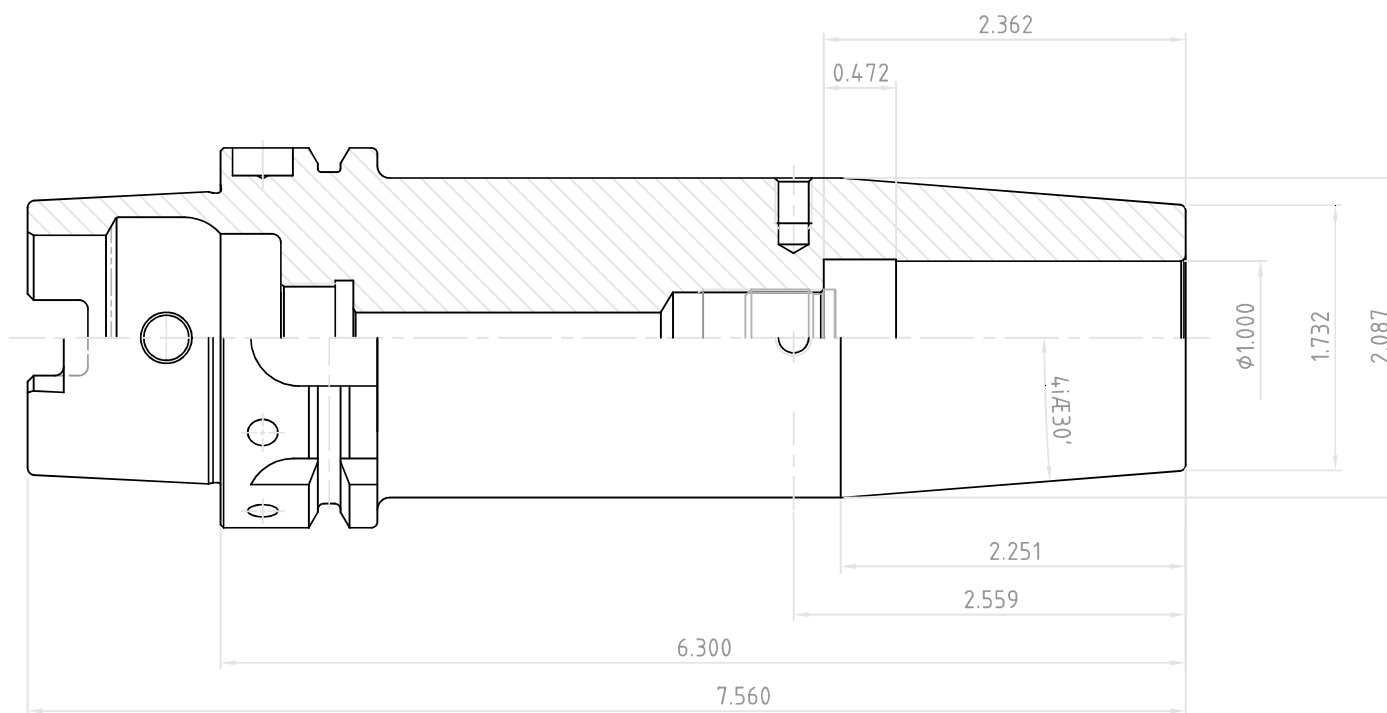
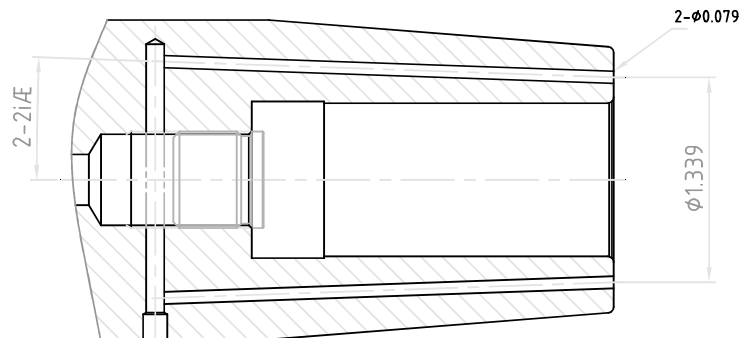

 YG-1 CO., LTD.	SSK CONTROL NUMBER	
	HSK63A-SFH1.000(25.400)C-6.300(160)	
EDP No.	VQ048J	SCALE 1 : 1