

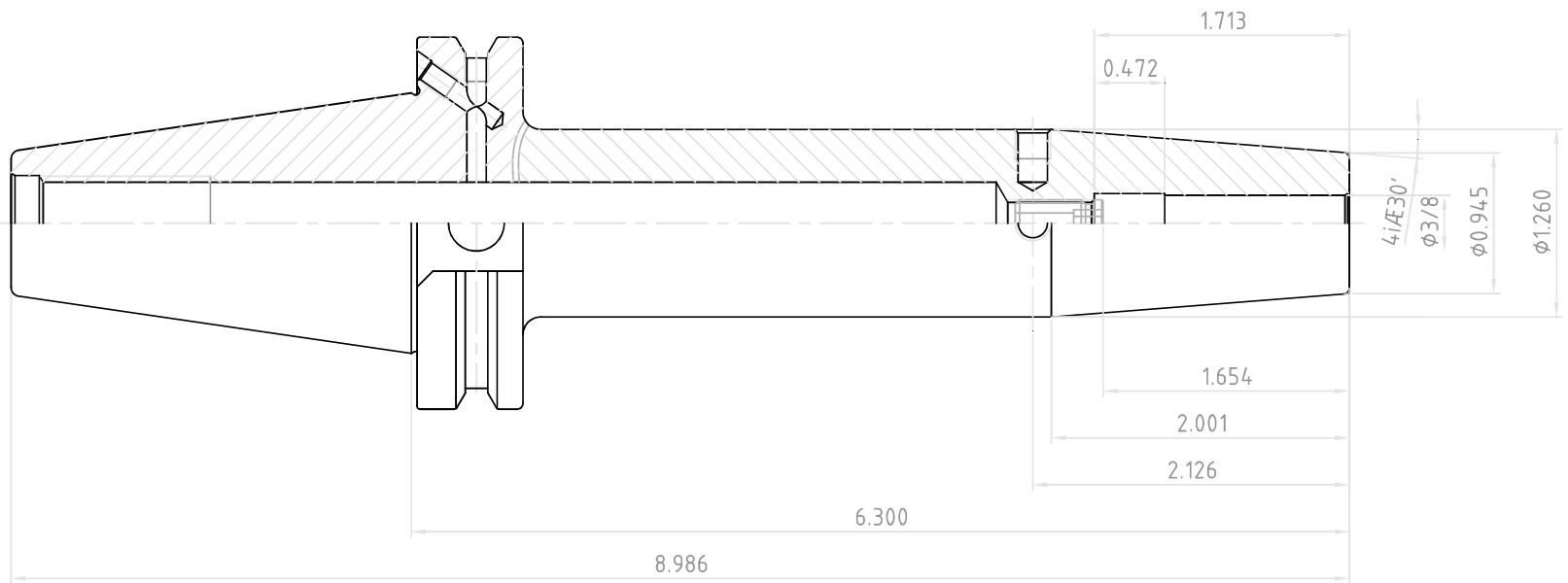

NO.	REVISIONS	DATE	DEVISER
1.			
2.			
3.			



 YG-1 CO., LTD.	SSK CONTROL NUMBER	
	CCT40AD/B-SFH3/8(9.525)-6.300(160)	
	EDP No.	VB030
	SCALE	1 : 1