

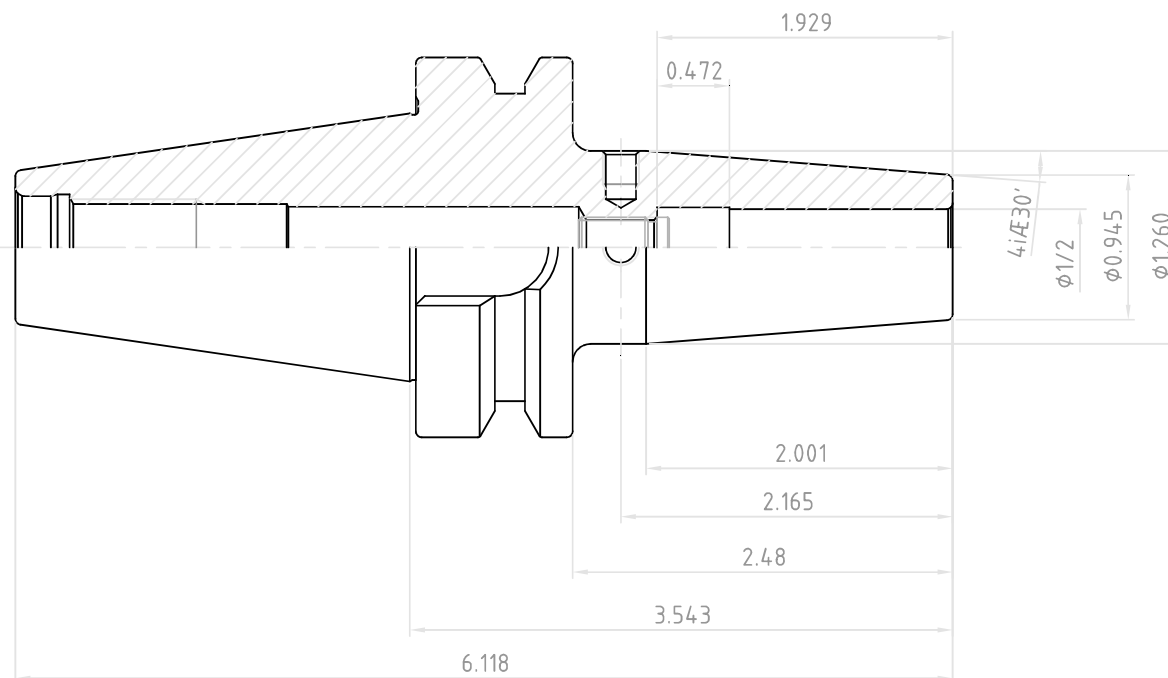

NO.	REVISIONS	DATE	DEVISER
1.			
2.			
3.			



 YG-1 CO., LTD.	SSK CONTROL NUMBER	
	CBT40-SFH1/2(12.700)-3.543(90)	
	EDP No.	VE032
	SCALE	1 : 1