

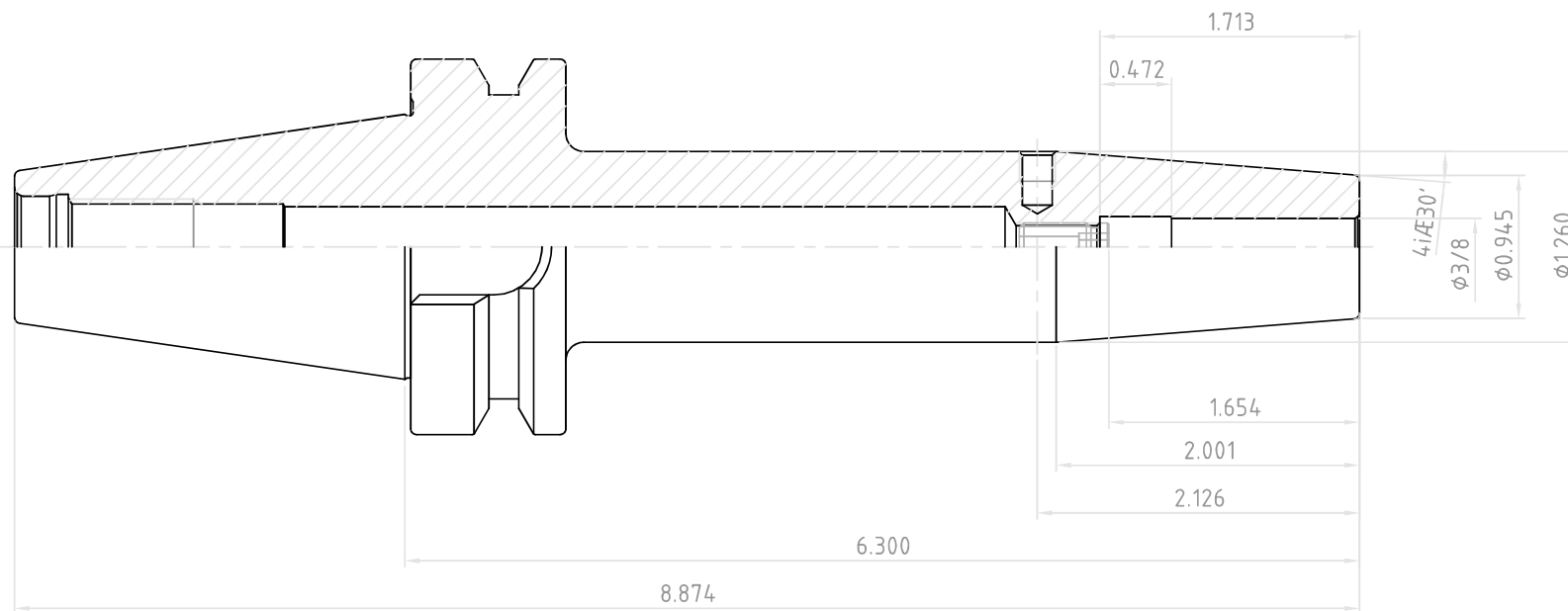

NO.	REVISIONS	DATE	DEVISER
1.			
2.			
3.			



 YG-1 CO., LTD.	SSK CONTROL NUMBER	
	CBT40-SFH3/8(9.525)-6.300(160)	
	EDP No.	VE030
		SCALE 1 : 1