

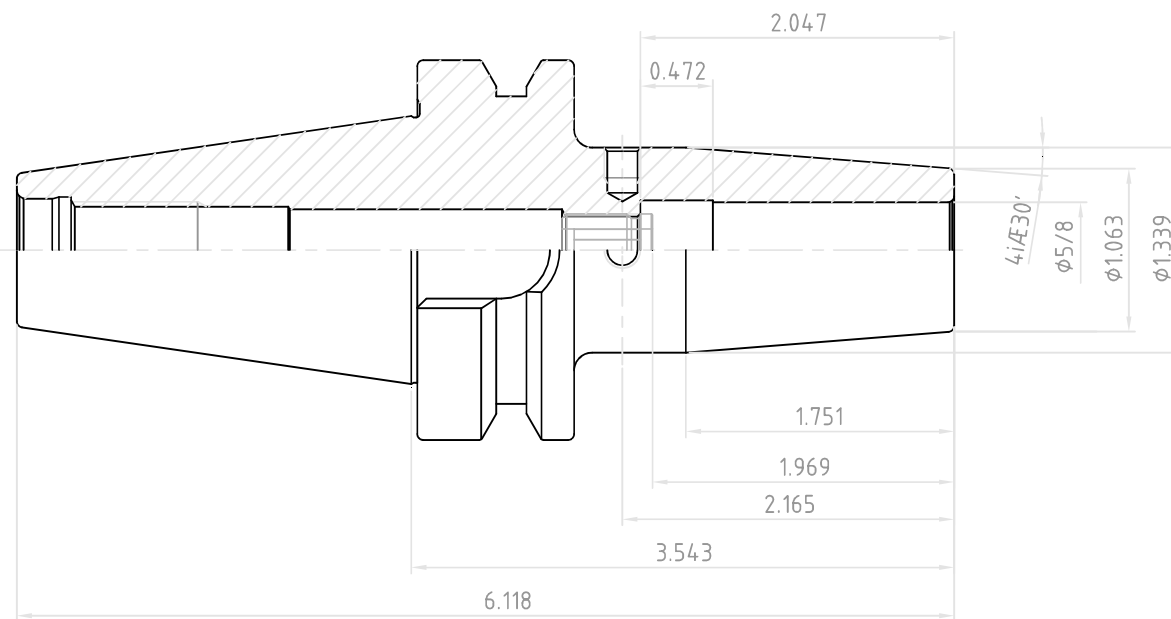

NO.	REVISIONS	DATE	DEVISER
1.			
2.			
3.			



 YG-1 CO., LTD.	SSK CONTROL NUMBER	
	CBT40-SFH5/8(15.875)-3.543(90)	
EDP No.	VE036	SCALE 1 : 1