

NO.	REVISIONS	DATE	DEVISER
1.			
2.			
3.			

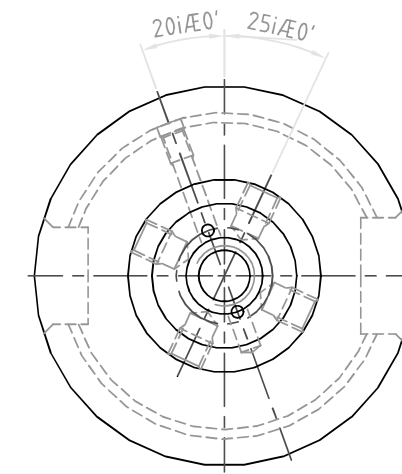
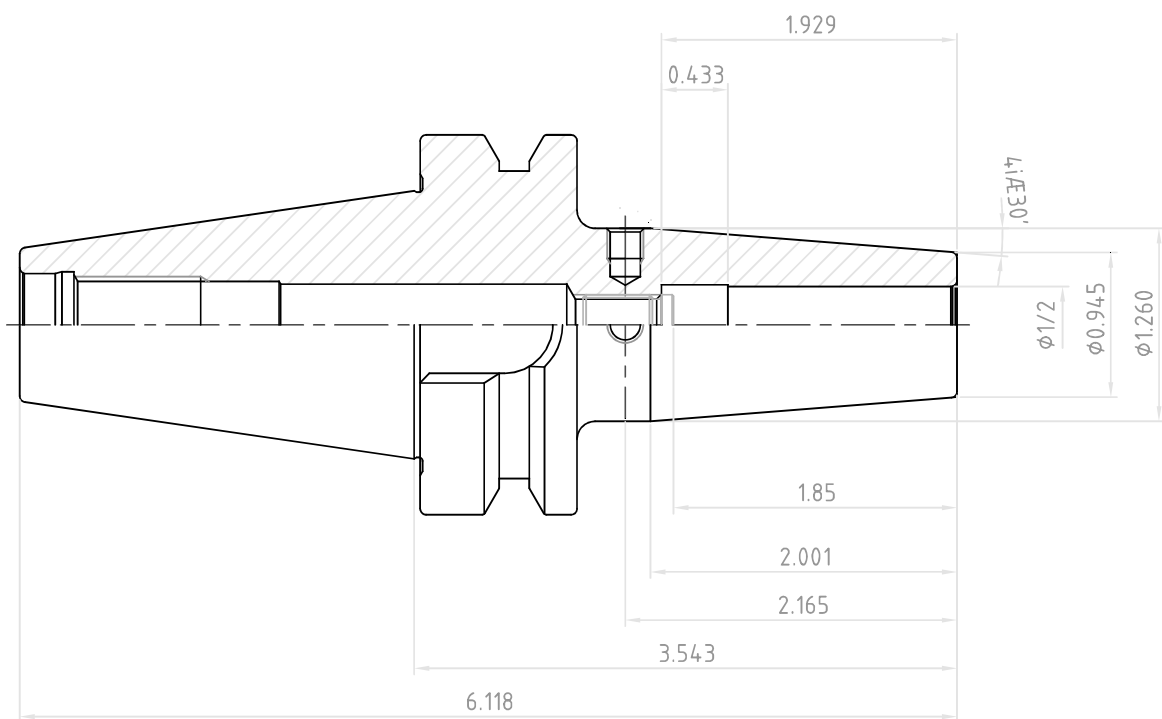
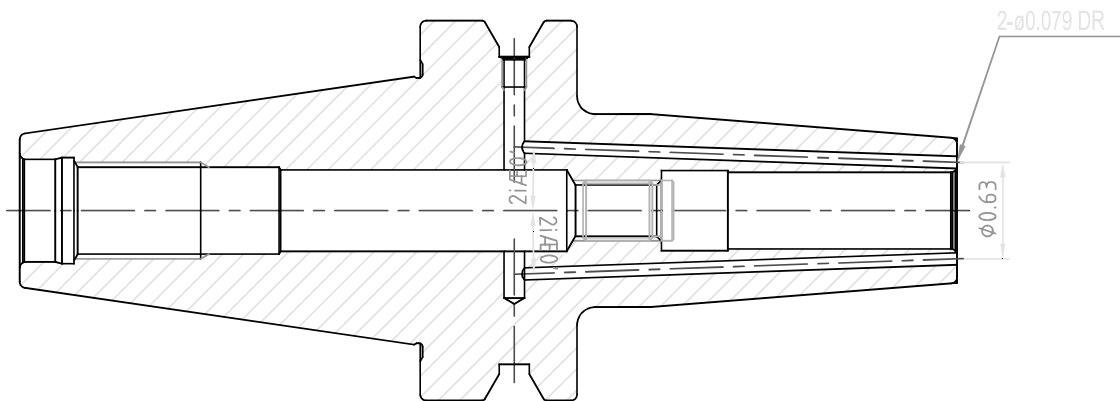

 YG-1 CO., LTD.	SSK CONTROL NUMBER		
	CBT40-SFH1/2(12.700)C-3.543(160)		
	EDP No.	VE032J	SCALE 1 : 1