

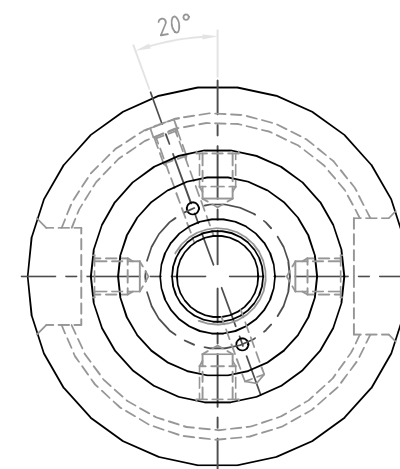

NO.	REVISIONS	DATE	DEVISER
1.			
2.			
3.			

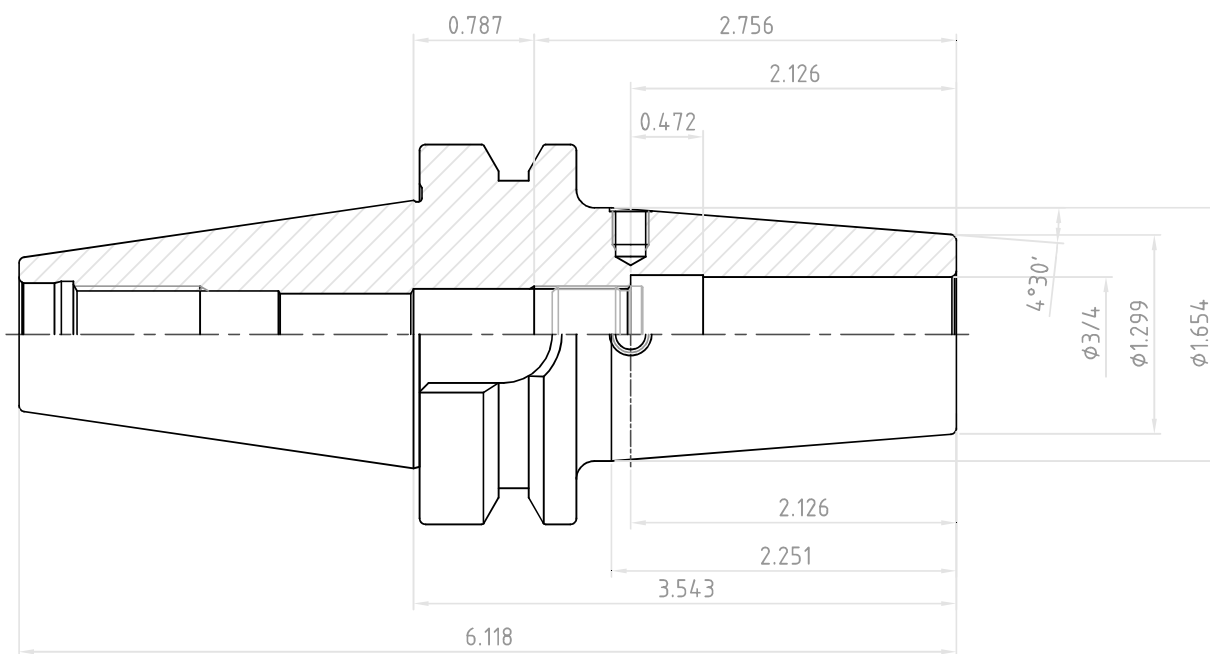
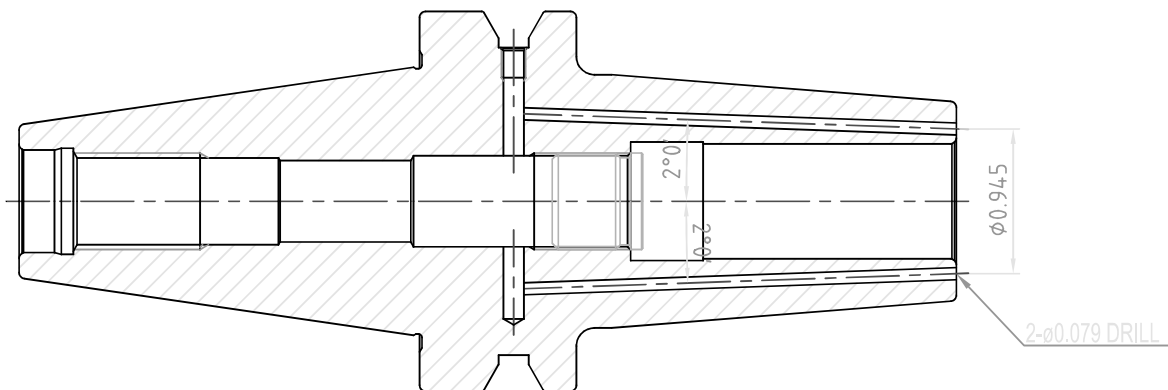

 YG-1 CO., LTD.	SSK CONTROL NUMBER		
	CBT40-SFH3/4(19.050)C-3.543(90)		
	EDP No.	VE40J	SCALE 1 : 1