

NO.	REVISIONS	DATE	DEVISER
1.			
2.			
3.			

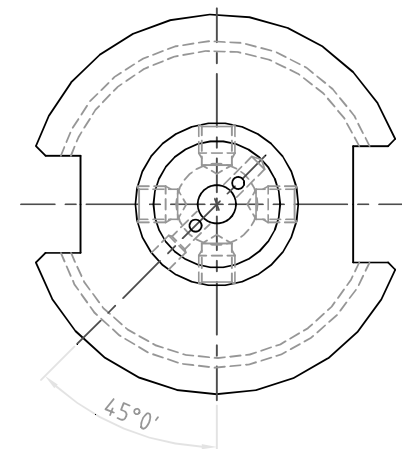
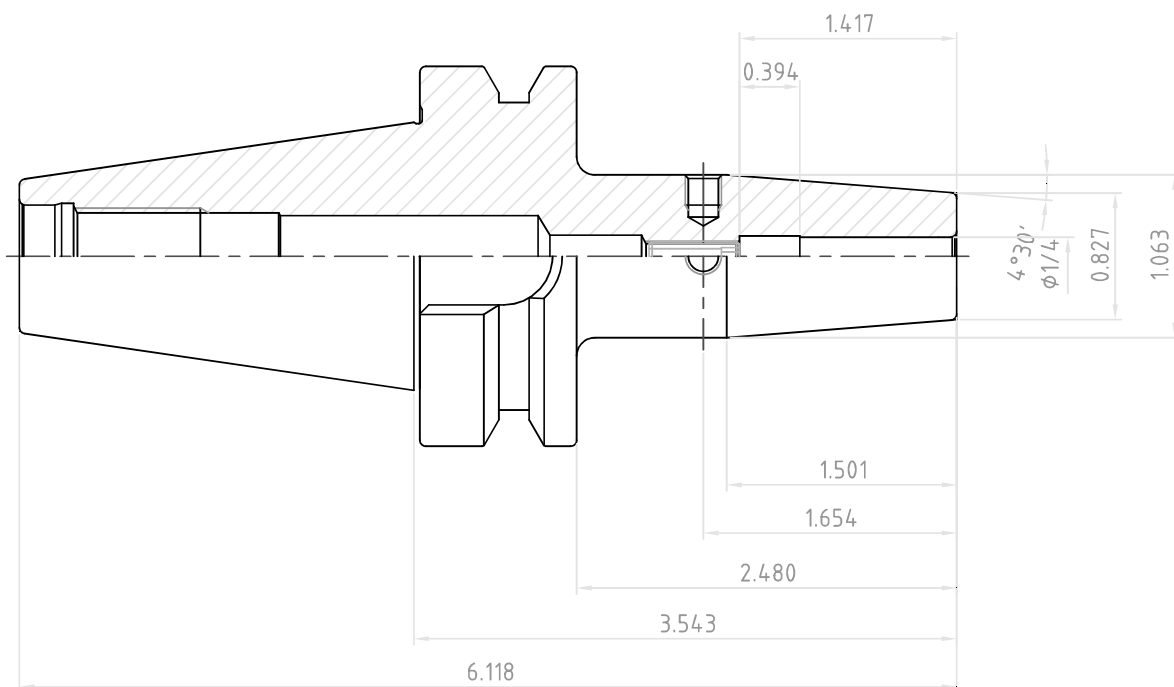
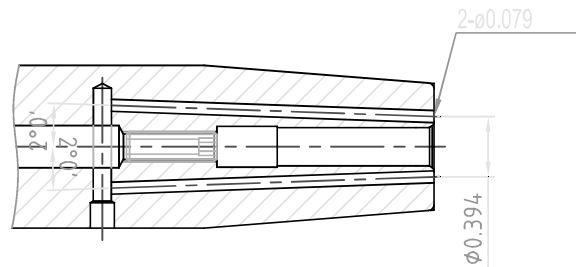

 YG-1 CO., LTD.	SSK CONTROL NUMBER		
	CBT40-SFH1/4(6.350)C-3.543(90)		
	EDP No.	VE024J	SCALE 1 : 1