

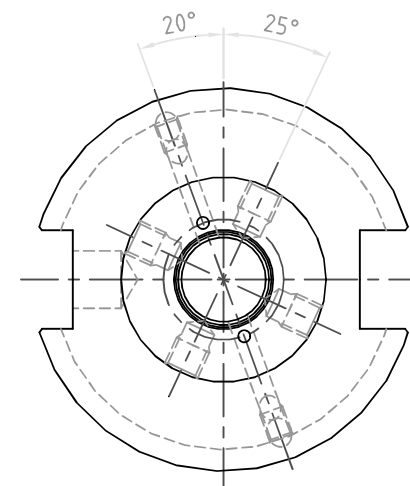

NO.	REVISIONS	DATE	DEVISER
1.			
2.			
3.			

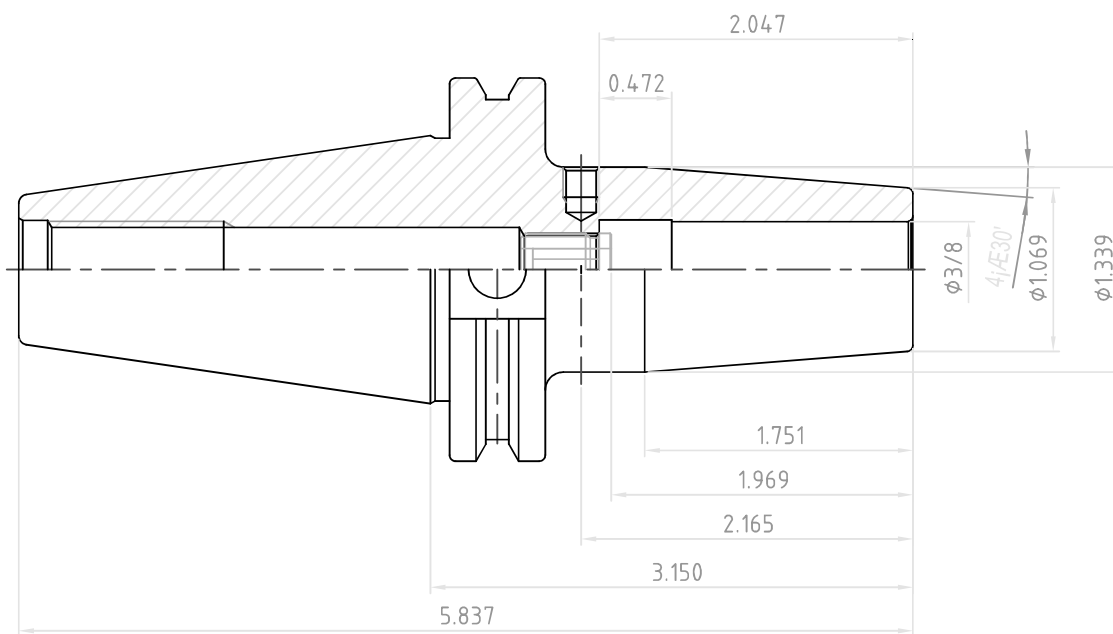
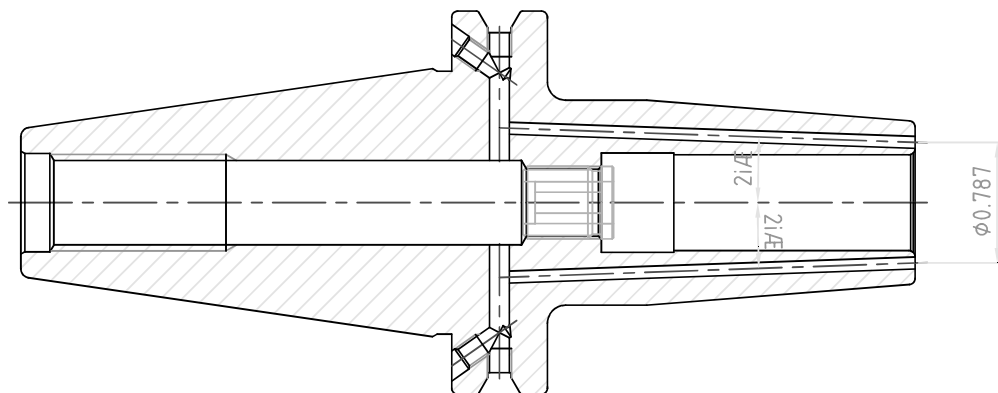

 YG-1 CO., LTD.	SSK CONTROL NUMBER	
	CAT40AD/B-SFH5/8(15.875)C-3.150(80)	
EDP No.	VK036J	SCALE 1 : 1