

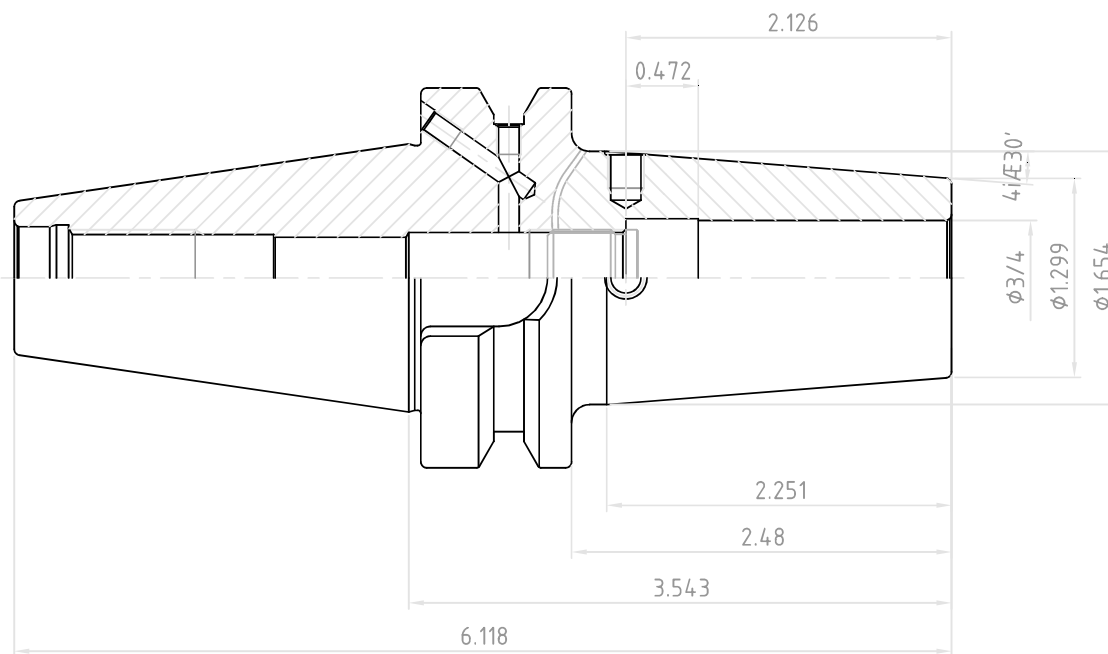

NO.	REVISIONS	DATE	DEVISER
1.			
2.			
3.			



 YG-1 CO., LTD.	SSK CONTROL NUMBER	
	BT40AD/B-SFH3/4(19.050)-3.543(90)	
	EDP No.	VH036
	SCALE	1 : 1